

EN Operating and installation instructions M Pure

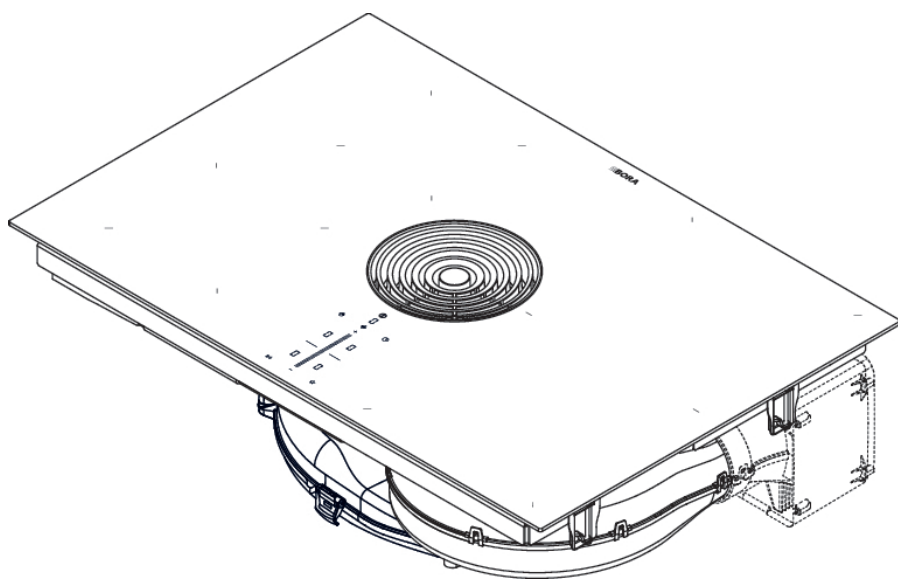

Contents

1	General information	4		
1.1	Validity.....	4	5.4.2	Fan power setting..... 21
1.2	Liability.....	4	5.4.3	Automatic extractor function..... 21
1.3	Product conformity.....	4	5.4.4	Switching the fan off..... 21
1.4	Presentation of information.....	4	5.4.5	Automatic after-run..... 21
			5.4.6	Filter service display..... 21
2	Safety	6	5.5	Cooktop functions..... 22
2.1	Intended use.....	6	5.5.1	Pan size recognition..... 22
2.2	People with limited abilities.....	6	5.5.2	Selecting a cooking zone..... 22
2.3	General safety instructions.....	7	5.5.3	Setting cooking zone power levels..... 22
2.4	Safety information for installation.....	8	5.5.4	Cooking zone power setting..... 22
2.4.1	Safety instructions – cooktop extractor installation.....	9	5.5.5	Cooking zone timer..... 22
2.4.2	Safety information for cooktop installation.....	10	5.5.6	Pause function..... 23
2.5	Safety instructions – operation.....	10	5.5.7	Variable heat retention function..... 23
2.5.1	Safety instructions – cooktop extractor operation.....	11	5.5.8	Bridging function..... 23
2.5.2	Safety instructions – cooktop operation.....	12	5.5.9	Automatic bridging function..... 24
2.6	Safety instructions – cleaning and maintenance.....	14	5.5.10	Switching off the cooking zone..... 24
2.6.1	Safety instructions – cleaning and maintenance of cooktop extractors.....	14	5.6	Safety features..... 24
2.6.2	Safety instructions – cleaning and maintenance of cooktops.....	14	5.6.1	Child lock..... 24
2.7	Safety instructions – repairs, servicing and spare parts.....	15	5.6.2	Cleaning lock..... 24
2.8	Safety instructions – disassembly and disposal.....	15	5.6.3	Residual heat indicator..... 24
			5.6.4	Safety shut-down..... 24
			5.6.5	Overheating protection..... 25
3	Technical data	16	6	Connect..... 25
3.1	M Pure.....	16	6.1	Installing the app..... 25
3.1.1	PURMA2/R appliance dimensions.....	16	6.2	Account..... 25
3.1.2	PURMU2/R appliance dimensions.....	17	6.3	Pairing..... 25
			6.4	BORA JOY app..... 25
4	Appliance description	17	7	BORA Assist..... 25
4.1	Model description.....	17	7.1	Cookware..... 25
4.2	System description.....	17	7.2	BORA Assist..... 25
4.2.1	Structure.....	17	7.2.1	Allocating Assists using the BORA JOY app.... 26
4.2.2	Operating panel.....	18	7.3	Activating BORA Assist..... 26
4.2.3	7-segment display.....	18	7.3.1	Adjusting the cooking programme..... 26
4.2.4	Lighting.....	18	7.3.2	Fry – accurate frying to the last degree..... 26
4.3	How the cooktop extractor works.....	18	7.3.3	Boil – for boiling water..... 26
4.4	How the induction cooktop works.....	19	7.3.4	Adjusting the cooking zone timer..... 26
			7.4	Starting BORA Assist using the BORA JOY app..... 26
5	Functions and operation	19	7.5	Switching BORA Assist off early..... 26
5.1	General operating instructions.....	19	7.6	Completion of a BORA Assist..... 27
5.2	Touch control.....	19	7.6.1	Extending the time..... 27
5.3	Operating the system.....	20	8	User menu..... 27
5.3.1	Switch on/off.....	20	8.1	Menu item Con: connectivity..... 27
5.3.2	Short-time timer.....	20	8.2	Menu item 1: volume of the acoustic signals..... 27
5.3.3	Recovery function.....	21	8.2.1	Sounds..... 28
5.4	Cooktop extractor functions.....	21	8.3	Menu item 2: Child lock..... 28
5.4.1	Fan power levels.....	21	8.4	Menu item 3: Show filter status and reset filter service display..... 28

8.5	Menu item 4: Duration of the automatic after-run function.....	28	11.7.7	Installation dimensions for installation variant B.....	40
8.6	Menu item 5: Touch zone reaction speed.....	28	11.8	Preparing the appliance.....	40
8.7	Menu item 6: LED test.....	28	11.9	Installing the cooktop.....	41
8.8	Menu item 7: Permanent pan size recognition.....	29	11.9.1	Inserting the cooktop.....	41
8.9	Menu item 8: Show software/hardware version.....	29	11.9.2	Securing the cooktop.....	41
8.10	Menu item 9: Safety shut-down.....	29	11.9.3	Connecting the appliance to the duct system.....	42
8.11	Menu item 0: Reset to factory settings.....	29	11.9.4	Making a connection with the back panel in installation variant A.....	42
9	Cleaning and maintenance	29	11.9.5	How to fit the odour filter.....	42
9.1	Cleaning agents.....	30	11.10	Connecting the power supply.....	42
9.2	Maintenance.....	30	11.11	Initial operation.....	43
9.3	Cleaning the cooktop.....	30	11.11.1	Dealer and service menu.....	43
9.4	Cleaning the cooktop extractor.....	30	11.11.2	Menu item B: Extraction system configuration.....	44
9.4.1	Cleaning the air inlet nozzle and stainless steel grease filter.....	30	11.11.3	Menu item C: Power management.....	44
9.4.2	Removing liquids from the appliance.....	31	11.11.4	Menu item D: Demo mode.....	44
9.5	Cleaning the air guiding housing.....	31	11.11.5	Function test.....	45
9.6	How to replace the odour filter.....	32	11.12	Sealing the appliance.....	45
10	Troubleshooting	34	11.13	Handover to user.....	45
11	Installation	35	12	Decommissioning, disassembly and disposal	45
11.1	General installation instructions.....	35	12.1	Decommissioning.....	45
11.1.1	Simultaneous operation of the cooktop extractor in the exhaust air mode with a fireplace dependent upon the air supply in the room.....	35	12.2	Disassembly.....	45
11.2	Scope of delivery.....	35	12.3	Environmentally-friendly disposal.....	46
11.3	Tools and aids.....	36	12.3.1	Disposal of transport packaging.....	46
11.4	Assembly instructions.....	36	12.3.2	Disposal of accessories.....	46
11.4.1	Installation clearances.....	36	12.3.3	Disposal of the old appliance.....	46
11.4.2	Minimum unit dimensions.....	36	13	Warranty, technical service, spare parts, accessories	46
11.4.3	Information on kitchen units.....	36	13.1	BORA manufacturer's warranty.....	46
11.5	Worktop cut-out.....	36	13.1.1	Warranty extension.....	47
11.5.1	Cut-out dimensions.....	37	13.2	Service.....	47
11.6	Preparing kitchen units for exhaust air models.....	37	13.3	Spare parts.....	47
11.6.1	Adapting kitchen units.....	37	13.4	Accessories.....	47
11.6.2	Installation dimensions.....	38	14	Product data sheets	48
11.7	Preparing kitchen units for recirculation models.....	38	14.1	PURMA2/PURMA2R product data sheet - cooktop extractor.....	48
11.7.1	Recirculation of air from the kitchen unit.....	38	14.2	M Pure - Cooktop product data sheet.....	49
11.7.2	Installation variants (A and B) for recirculation appliances.....	38			
11.7.3	Preparing the kitchen unit for installation variant A.....	38			
11.7.4	Installation dimensions for installation variant A.....	39			
11.7.5	Extending the telescopic pull-out of the air purification box.....	39			
11.7.6	Preparing the kitchen unit for installation variant B.....	40			

1 General information

These instructions and all accompanying documents contain important information to protect you from injury and prevent damage to the appliance.

► Please by all means adhere to all documents that form part of the scope of delivery.

Assembly, installation and commissioning must always occur in line with national laws, regulations and standards. The work must be performed by qualified specialists who know and comply with the additional regulations of the local energy supply companies.

All safety and warning information as well as the handling instructions in the accompanying documents must be observed.

Please keep these instructions in a safe place and pass them on to the next owner where applicable.

1.1 Validity

These instructions apply to several appliance versions. It is therefore possible that some of the features described do not apply to your appliance. The details of the figures contained herein may differ and are to be understood as schematic diagrams.

1.2 Liability

. BORA Holding GmbH, BORA Vertriebs GmbH & Co KG, BORA APAC Pty Ltd and BORA Lüftungstechnik GmbH – hereinafter referred to as BORA – do not assume any liability for damage arising from disregard for or non-adherence to the documents included in the scope of delivery!

Furthermore, BORA shall not be held liable for damage caused by improper installation or failure to observe the safety and warning information!

1.3 Product conformity

The appliances comply with the following EU/EC regulations:

- 2009/125/EC Ecodesign Directive
- 2011/65/EU RoHS Directive

BORA Vertriebs GmbH & Co KG hereby declares that the PURMA2, PURMA2R, PURMU2 and PURMU2R radio equipment complies with directive 2014/53/EU.

The appliance supports the following frequency bands:

- 2.4 GHz: 100 mW max.

The appliances comply with the following UK regulations:

UK – Statement of Compliance The Product Security and Telecommunications Infrastructure (Security Requirements for Relevant Connectable Products) Regulations 2023.

The full text of the EU declaration of conformity and the UK statement of compliance is available at the following address:

<https://www.bora.com>

1.4 Presentation of information

The article described in these instructions is hereinafter also referred to as an appliance. All measurements are provided in millimetres.

Operating instructions

► Always follow all instructions in the prescribed order.

Enumerations

- Enumeration 1
- Enumeration 2

Info points

 Information notes point to special features that must be taken into account.

Safety and warning information

DANGER



Type and source of danger

Results of non-compliance

► Measures to minimise risk

Please note:

- warning symbols draw attention to a high risk of injury.
- The signal word indicates the severity of that risk.

Warning symbol	Signal word	Risk
	Danger	Indicates an immediate, hazardous situation which causes death or serious injury if not respected.
	Warning	Indicates a potentially hazardous situation which can cause death or serious injury if not respected.
	Caution	Indicates a potentially hazardous situation which can cause minor injury if not respected.
	Note	Indicates a potentially hazardous situation which can cause property damage if not respected.

Tab. 1.1 Meaning of the warning symbols and signal words

2 Safety

The appliance complies with the stipulated safety requirements. The user is responsible for the safe use of the appliance, cleaning and maintenance. Improper use can lead to personal injury and damage to property.

2.1 Intended use

The appliance is solely intended for preparing food in private households.

This appliance is not intended for:

- outdoor use
- heating rooms
- cooling, ventilating or dehumidifying rooms
- use in mobile installation sites such as motor vehicles, ships or aeroplanes
- use with an external timer or a separate remote control system
- use at altitudes of over 2000 m (metres above sea level)
- use when not fully installed

Any other use or any use that goes beyond that which is described here is classed as unintended.

i BORA does not assume any liability for damages caused by incorrect installation, improper use or incorrect operation.

All misuse is prohibited!

2.2 People with limited abilities

Children

The appliance can be used by children aged 8 and over if they are supervised or have been instructed how to use the appliance safely and understand the resultant risks. Children must not play with the appliance.

- ▶ Use the childproofing feature in order to prevent children from switching on the appliance or changing the settings when they are unattended.
- ▶ Supervise children in the vicinity of the appliance.
- ▶ Do not store any items that could be of interest to children in storage spaces above or behind the appliance. Otherwise, they will be tempted to climb onto the appliance.

i Any work involving cleaning and maintenance must not be carried out by children unless they are supervised at all times while doing so.

People with reduced physical, sensory or mental capacities

The appliance can be used by people with reduced physical, sensory or mental capacities or a lack of experience and/or knowledge if they are supervised or have been instructed how to use the appliance safely and understand the resultant risks. Operation can be restricted using the child lock.

DANGER

Risk of burns from hot cookware and food

Handles projecting over the edge of the worktop are asking to be grabbed.

- ▶ Keep children away from hot cooking zones or ensure they are supervised at all times.
- ▶ Do not turn pot and pan handles so they stick out beyond the work surface.
- ▶ Make sure that hot pots and pans cannot be pulled down.
- ▶ If necessary, use suitable stove guards or covers.
- ▶ Only use stove guards and covers that are approved by the appliance manufacturer; otherwise, there is a risk of accidents.
- ▶ To choose a suitable stove guard, contact your specialist retailer or the BORA Service Team.

2.3 General safety instructions

DANGER

Packaging components are a choking hazard

Packaging components (e.g. film, polystyrene) can be life-threatening for children.

- ▶ Store all packaging components out of reach of children.
- ▶ Dispose of the packaging properly and immediately.

DANGER

Risk of electric shock or injury from damaged surfaces

The underlying electronics can be exposed or damaged due to fissures, fractures or cracks in appliance surfaces (e.g. damaged glass), particularly in the vicinity of the operating unit. This can cause an electrical shock. Furthermore, a damaged surface can cause injuries.

- ▶ Do not touch the damaged surface.
- ▶ If there are any cracks, fissures or fractures, switch the appliance off immediately.
- ▶ Securely disconnect the appliance from the mains using the circuit breaker, fuses, automatic circuit breakers or contactor.
- ▶ Contact the BORA Service Team.

WARNING

Risk of injury or damage due to incorrect components or unauthorised modifications

Incorrect components can lead to personal injury or damage to the appliance. Modifications, additions or alterations to the appliance can lead to safety risks.

- ▶ Only use original components.
- ▶ Do not make any modifications, additions or alterations to the appliance.

WARNING

Risk of injury due to mechanical damage on the appliance

Mechanical damage (e.g. cracks, deformation, separation of adhesive seals, etc.) to the appliance, as well as to cables and accessories can cause injuries.

- ▶ Do not operate the appliance.
- ▶ Do not try to repair or replace damaged components yourself.
- ▶ Contact the BORA Service Team.

CAUTION

Appliance components can cause injury if dropped

Appliance components can cause injury if you drop them.

- ▶ Place any appliance components that have been removed in a safe place near the appliances.
- ▶ Ensure that no components removed from the appliances can fall on the floor.

CAUTION

Risk of injury from heavy lifting

If not handled correctly, carrying and installing appliances can cause injury to the limbs or torso.

- ▶ If necessary, carry and install the appliance with another person.
- ▶ Use appropriate aids to prevent damage or injury.

CAUTION

Damage from improper use

The appliance surfaces must not be used as work or storage surfaces. This can damage the appliances (particularly in the case of hard and sharp objects).

- ▶ Never use the appliances as work or storage surfaces.
- ▶ Keep hard or sharp objects away from the appliance surfaces.

PLEASE NOTE

Faults and errors

In the event of faults or incorrect use, error messages will be displayed.

- ▶ In the case of faults and errors, follow the instructions in the “Troubleshooting” chapter.
- ▶ In the event of any faults or errors that are not mentioned, switch the appliance off and contact BORA Service.

PLEASE NOTE

Appliance damage caused by pets

Pets may damage the appliance or injure themselves.

- ▶ Keep pets away from the appliance.

2.4 Safety information for installation

DANGER

Risk of injury from incorrect assembly

Failure to observe the installation instructions can lead to injury.

- ▶ The appliance must only be installed and assembled by trained specialists who are familiar with and comply with the standard national regulations and supplementary regulations of the local utility companies.
- ▶ The appliance may only be installed with the power disconnected.
- ▶ Work on electrical components must only be conducted by trained electrical personnel.
- ▶ Conduct all work extremely attentively and conscientiously.
- ▶ Before handing the appliance or system over to the end user, ensure that it has been correctly installed.

 DANGER**Risk of electric shock from damaged appliance**

A damaged appliance can cause an electric shock.

- ▶ Check the appliance for visible damage prior to installation.
- ▶ Do not install or connect any damaged appliances.
- ▶ Do not operate any damaged appliances.

PLEASE NOTE**Appliance damage caused by incorrect wiring**

The electrical safety of the appliance is only guaranteed if it is connected to a protective conductor system that has been installed in line with regulations.

- ▶ Work on electrical components must only be conducted by trained electrical personnel.
- ▶ Ensure that this basic safety precaution is met. The appliance must be suitable for the regional voltage and frequency.
- ▶ Check the information on the identification plate and in the event of deviations, do not connect the appliance.
- ▶ Do not connect the appliance to the mains until the duct system has been installed or the recirculation filter has been fitted.
- ▶ Only use the connection cables supplied.

PLEASE NOTE**Appliance damage caused by incorrect installation clearances**

Failure to adhere to installation clearances can lead to damage to the appliance and kitchen units, as well as restricted functions.

- ▶ During installation maintain the minimum clearance stated in the Installation chapter.

2.4.1 Safety instructions – cooktop extractor installation** DANGER****Risk of smoke inhalation**

When the cooktop extractor is used in exhaust air mode, it draws in air from the room it is installed in and from neighbouring rooms. Without sufficient air, there will be a drop in air pressure. When used at the same time as a fireplace that is dependent on the air in the room, noxious gases can be sucked into the living areas from the chimney or outlet shaft.

- ▶ Make sure that there is always a sufficient air supply.
- ▶ Only use reliable, tried-and-tested switching devices, (e.g. window contact switch, low pressure warning device) and have them approved by a qualified expert (certified chimney sweep).

 WARNING**Risk of injury due to turning fan wheel**

There is a risk of injury while the fan is turning.

- ▶ Only install the device with the power disconnected.
- ▶ Connect both sides of the fan to the duct system before commissioning.

CAUTION

Risk of injury due to turning fan wheel

There is a risk of the vicinity of the fan being reached in the case of short air channels.

- ▶ Never reach through the air outlet into the vicinity of the fan.
- ▶ Always install fans so that it is not possible to touch them via the air outlet.
- ▶ In the case of air channels shorter than 900 mm between the fan and air outlet, install a guard to prevent access.
- ▶ Odour filters (activated charcoal filters) do not provide sufficient protection.

2.4.2 Safety information for cooktop installation

DANGER

Risk of electric shock from damaged power supply cable

If the power supply cable is damaged (e.g. during installation or by coming into contact with hot cooking surfaces), this can cause an (lethal) electric shock.

- ▶ Make sure that the connection cable does not become trapped or damaged.
- ▶ Make sure that the power supply cable does not come into contact with hot cooking surfaces.

DANGER

Risk of electric shock from incorrect mains connection

Connecting the appliance to the mains incorrectly poses a risk of electric shock.

- ▶ Make sure that the appliance has a fixed connection to the mains voltage.
- ▶ Make sure that the appliance is connected to a properly installed protective conductor system.
- ▶ Make sure that technical equipment is provided to enable all of the appliance's poles to be disconnected from the mains with a contact opening width of at least 3 mm (circuit breaker and automatic circuit breakers, fuses, contactor).

2.5 Safety instructions – operation

DANGER

Risk of fire from overheated oil or fat

Oil or fat in the pot can quickly heat up and ignite.

- ▶ Never leave the appliance unattended when cooking with oil or fat.
- ▶ Never extinguish oil and fat fires with water.
- ▶ Switch off the appliance.
- ▶ Extinguish the fire using a pan lid or a fire blanket, for example.

WARNING

Risk of burning from hot appliances

Certain appliances and their exposed parts become hot during use. They should be left to cool down completely after switching off. Touching hot surfaces can cause serious burns.

- ▶ Do not touch hot appliances.
- ▶ Pay attention to the residual heat indicator.

WARNING

Risk of burns due to power cut

During or after a power cut a cooktop that was previously in operation may still be hot.

- ▶ Do not touch the appliance while it is still hot.
- ▶ Keep children away from the hot appliance.

WARNING

Risk of burning and fire from hot objects

The appliance and its exposed parts are hot during operation and the cooling phase. Objects in contact with hot appliance components heat up very quickly and can cause severe burns (this particularly applies to metal objects such as knives, forks, spoons, lids or appliance components) or catch fire.

- ▶ Do not place any items on the appliance.
- ▶ Please use suitable accessories (pot holders, oven gloves).
- ▶ Do not simply rely on the pan size recognition function on induction cooktops; always switch the appliance off after use.

CAUTION

Damage caused by hot cookware

Hot cookware can damage certain components in the appliance.

- ▶ Do not put hot cookware down in the area of the operating panel or cooktop display.
- ▶ Keep hot cookware away from the air inlet nozzle.

PLEASE NOTE

Appliance damage

Incorrect use may cause damage to the appliance.

- ▶ Make sure that the base of the cookware as well as the appliance surfaces are clean and dry.
- ▶ Always lift (do not drag) cookware to prevent scratching and abrasion on the appliance surface.
- ▶ Do not use the appliance as a storage surface.
- ▶ Always switch off the appliance after use.

2.5.1 Safety instructions – cooktop extractor operation

DANGER

Risk of smoke inhalation

When the cooktop extractor is used in exhaust air mode, it draws in air from the room it is installed in and from neighbouring rooms. Without sufficient air, there will be a drop in air pressure. When used at the same time as a fireplace that is dependent on the air in the room, noxious gases can be sucked into the living areas from the chimney or outlet shaft.

- ▶ Make sure that there is always a sufficient air supply.
- ▶ Only use reliable, tried-and-tested switching devices, (e.g. window contact switch, low pressure warning device) and have them approved by a qualified expert (certified chimney sweep).

⚠ WARNING**Fire risk from flambéing**

While the cooktop extractor is working, it sucks up grease from cooking. Flambéing food can cause the grease to catch fire.

- ▶ Clean the cooktop extractor regularly.
- ▶ Never work with a naked flame while the cooktop extractor is running.

CAUTION**Damage caused by objects or paper suctioned in**

Small and light items, such as cleaning cloths made from material or paper, can be suctioned into the cooktop extractor. This can damage the fan or impair the exhaust performance.

- ▶ Do not store any items or paper on the cooktop extractor.
- ▶ Only operate the integrated cooktop extractor with the grease filter fitted.

CAUTION**Damage caused by grease and dirt deposits**

Grease and dirt deposits can prevent the cooktop extractor from functioning properly.

- ▶ Never use the cooktop extractor without a correctly fitted stainless steel grease filter.

PLEASE NOTE**Increased humidity**

When cooking, additional moisture is released into the ambient air. In recirculation mode, only a slight amount of moisture is removed from the cooking vapour.

- ▶ When using the recirculation mode, ensure a sufficient supply of fresh air, e.g. by opening a window.
- ▶ Ensure a normal and comfortable room climate (humidity of 45 – 60%), e.g. by opening natural ventilation openings or using domestic ventilation systems.

2.5.2 Safety instructions – cooktop operation**⚠ DANGER****Danger of fire caused by leaving the cooktop unattended**

Oil or fat in the pot can quickly heat up and ignite.

- ▶ Never leave oil or fat to heat up unattended.
- ▶ Never extinguish oil and fat fires with water.
- ▶ Switch off the cooktop.
- ▶ Extinguish the fire using a pan lid or a fire blanket, for example.
- ▶ Use only the intended cookware when using BORA Assist and do not leave the cooktop unattended.

DANGER

Danger of explosion caused by flammable liquids

Flammable liquids in the vicinity of a cooktop can explode and cause serious injury.

- ▶ Do not spray aerosols near the appliance when it is in use.
- ▶ Do not place any flammable liquids in the vicinity of a cooktop.

WARNING

Risk of burns from hot liquids boiling over

Unattended pans can boil over allowing hot liquids to escape.

- ▶ Keep an eye on pans when cooking.
- ▶ Ensure that pans do not boil over.
- ▶ Always switch off the appliance after use.
- ▶ Use only the intended cookware when using BORA Assist and do not leave the cooktop unattended.

WARNING

Risk of burns from hot steam

Liquid between the cooking zone and cookware base can evaporate and cause burns.

- ▶ Make sure that the cooking zone and the cookware base are always dry.

PLEASE NOTE

Damage caused by sugary and salty foods

Sugary and salty foods and juices can damage the hot cooking zone.

- ▶ Make sure sugary and salty foods or juices do not get onto the cooking zone while it is hot.
- ▶ Remove sugary and salty foods and juices from the hot cooking zone immediately.

CAUTION

Electromagnetic radiation

Effect on pace makers, hearing aids and metal implants. Induction cooktops generate a high-frequency electromagnetic field in the area of the cooking zones. The cooking zones may affect pacemakers, hearing aids or metal implants negatively or disturb their function when in close proximity.

- ▶ If in doubt, contact the manufacturer of your medical device or your doctor.

2.6 Safety instructions – cleaning and maintenance

PLEASE NOTE

Appliance damage due to soiled appliances

Dirt can lead to damage, restriction of functions, or bothersome odours.

- ▶ Clean the appliance regularly.
- ▶ Remove dirt immediately.
- ▶ When cleaning, only use non-abrasive detergents to prevent scratching and abrasion on the surface.
- ▶ When cleaning, ensure that no water penetrates the appliance. Use only a slightly damp cloth.
- ▶ Never spray the appliance with water. Water penetration can cause damage.
- ▶ Do not use a steam cleaner for cleaning. Steam can cause a short circuit on live parts and thus lead to property damage.
- ▶ Please follow all instructions in the “Cleaning and Maintenance” chapter.

2.6.1 Safety instructions – cleaning and maintenance of cooktop extractors

DANGER

Risk of fire from fat deposits

The risk of fire can be increased by failure to clean the grease filter properly and on a regular basis, or if the filter change is overdue.

- ▶ Clean and replace the filter at regular intervals.

WARNING

Risk of injury when opening the bottom housing cover

There is a risk of injury while the fan is turning.

- ▶ Switch off the appliance and disconnect it from the mains before removing covers in the vicinity of the fan.

WARNING

Risk of injury due to turning fan wheel

If the fan wheel is turning during a filter change, this may result in injuries.

- ▶ Ensure that the appliance is switched off before changing the odour filter (activated charcoal filter).

PLEASE NOTE

Appliance damage and malfunctions

Soiled ventilation openings can lead to component damage and malfunctions.

- ▶ Keep all ventilation openings open and clean.

2.6.2 Safety instructions – cleaning and maintenance of cooktops

WARNING

Risk of burns from hot surfaces

There is a risk of burns when cleaning hot cooktops.

- ▶ Only clean the cooktops once they have cooled.
- ▶ Pay attention to the residual heat indicator.

2.7 Safety instructions – repairs, servicing and spare parts

DANGER

Risk of injury when carrying out repairs

Insufficient expertise can lead to injury when carrying out repairs.

- ▶ The appliance must only be repaired and serviced by trained specialists who are familiar with and comply with the standard national regulations and supplementary regulations of the local utility companies.
- ▶ Safely disconnect the appliance from the mains supply.
- ▶ Work on electrical components must only be conducted by trained electrical personnel.
- ▶ A damaged power supply cable must be replaced by a suitable power supply cable.

WARNING

Risk of injury or damage from improper repairs

Incorrect components can lead to personal injury or damage to the appliance. Modifications, additions or alterations to the appliance can lead to safety risks.

- ▶ Only use original spare parts for repairs.
- ▶ Do not make any modifications, additions or alterations to the appliance.

2.8 Safety instructions – disassembly and disposal

DANGER

Risk of injury during disassembly

Insufficient expertise can lead to injury when disassembling the appliance.

- ▶ It must only be disassembled by trained specialists who are familiar with and comply with the standard national regulations and supplementary regulations of the local utility companies.
- ▶ Safely disconnect the appliance from the mains supply.
- ▶ Work on electrical components must only be conducted by trained electrical personnel.

DANGER

Risk of electric shock from incorrect disconnection

Incorrectly disconnecting the appliance from the mains results in a risk of electric shock.

- ▶ Safely disconnect the appliance from the mains supply.
- ▶ Use an authorised measuring device to ensure that there is no power to the appliance.
- ▶ Do not touch exposed contacts on the electronic unit as they may contain residual charge.

DANGER

Risk of electric shock from residual charge

Electrical components in the appliance can contain residual charge and cause an electric shock.

- ▶ Do not touch any exposed contacts.

3 Technical data

3.1 M Pure

Parameter	Value
Multiphase supply voltage	380-415 V 2N/3N
Single-phase supply voltage	220-240 V
Frequency	50-60 Hz
Maximum power consumption	7360 W (4400 W / 3600 W)
Three-phase power supply/fuse protection	3 x 16 A
Two-phase power supply/fuse protection	2 x 16 A
Single-phase power supply/fuse protection	1 x 32 A (1 x 20 A / 1 x 16 A)
Dimensions (width x depth x height)	760 x 515 x 199 mm
Weight (incl. accessories/packaging)	22.3 kg (PURMA2, PURMA2R) 23.6 kg (PURMU2, PURMU2R)
Cooktop	
Surface material	Glass ceramic
Cooktop power levels	1-9, P
Front left cooking zone size	Ø 210 mm
Front left cooking zone output	2300 W
Front left cooking zone power setting output	3000 W
Rear left cooking zone size	Ø 175 mm
Rear left cooking zone output	1400 W
Rear left cooking zone power setting output	2100 W
Front right cooking zone size	230 x 230 mm
Front right cooking zone output	2100 W
Front right cooking zone power setting output	3000 W
Rear right cooking zone size	230 x 230 mm
Rear right cooking zone output	2100 W
Rear right cooking zone power setting output	3000 W
Exhaust air system	
Cooktop extractor power levels	1-9, P
Exhaust air connection	BORA Ecotube
Recirculation system	
Cooktop extractor power levels	1-9, P
Size of exhaust opening (W x H)	445 x 137 mm
Activated charcoal filter service life	150 hrs (1 year)

Tab. 3.1 Technical data for M Pure

3.1.1 PURMA2/R appliance dimensions

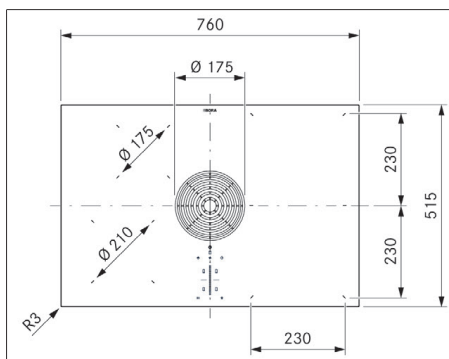

Fig. 3.1 PURMA2/R appliance dimensions top view

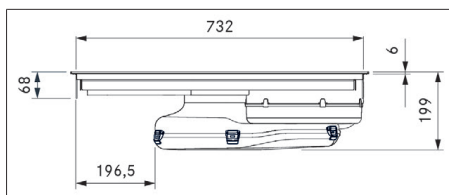

Fig. 3.2 PURMA2/R appliance dimensions front view

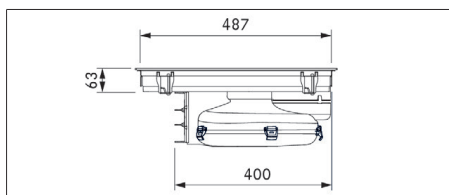

Fig. 3.3 PURMA2/R appliance dimensions side view

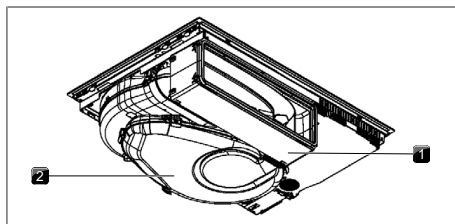

Fig. 4.3 Recirculation variant rear view

- [1] Air purification box [2] Air guiding housing

4.2.2 Operating panel

The appliance is operated via a central touch operating panel.

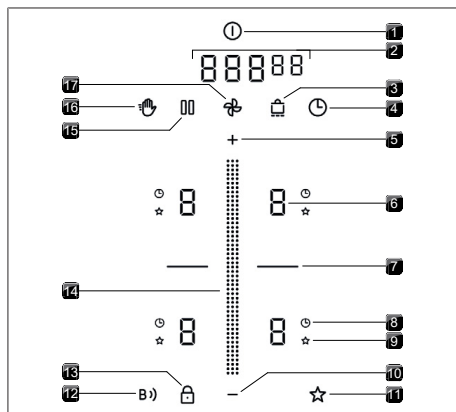

Fig. 4.4 Operating panel

- [1] Power button [2] Multi-function display
 [3] Heat retention button [4] Short-time timer
 [5] Plus button [6] Cooking zone indicator
 [7] Bridging button [8] Cooking zone timer indicator
 [9] Minus button
 [10] Connect button
 [11] Assist button [12] Child lock button
 [13] Slider [14] Pause button
 [15] Fan button [16] Cleaning button
 [17] Fan button

4.2.3 7-segment display

Multi-function display

Indicator	Meaning
- 9	Power levels
P	Power setting

Indicator	Meaning
□	Inactive
A	Automatic extractor function
∩	Automatic after-run
F	Filter service indicator
0000	Time (minutes ^{seconds})
e.g. E	Error code

Tab. 4.3 Meaning of the 7-segment displays

Cooking zone indicator

Indicator	Meaning
1-9	Power level
P	Power setting
-	Heat retention level 1
≡	Heat retention level 2
≡≡	Heat retention level 3
U	Pan size recognition
A	Assist function
□	Inactive
H	Residual heat indicator (cooking zone is switched off but still hot)
E	Error

Tab. 4.4 Meaning of the 7-segment displays

4.2.4 Lighting

The appliance automatically adapts the display lighting to the current operating conditions. Unavailable functions are not shown and inactive functions are dimmed.

4.3 How the cooktop extractor works

The cooktop extractor is either operated as an exhaust air system or recirculation system.

Exhaust air operating mode

The cooking vapour is guided by the fan into the open air via the duct system.

Recirculation mode

The fan channels the cooking vapours into the odour filter (activated charcoal filter). The odour filter absorbs cooking odours that arise during cooking. The purified air is fed back into the room.

For health and hygiene reasons, the odour filter must be replaced at the recommended intervals (Cleaning and maintenance).

- i** In recirculation mode, ensure sufficient ventilation and aeration to expel humidity.

4.4 How the induction cooktop works

Induction cooking zones heat the cookware via a magnetic field. The pot base is heated directly. The cooking zone is only heated indirectly. Cooking zones featuring induction technology only work with suitable cookware (magnetisable base with sufficient diameter).

Power levels

The high power output of induction cooktops results in the very quick heating up of cookware. In order to avoid burning food, slight adjustment is needed in comparison to conventional cooking systems when selecting the power level.

The specifications provided in the table are standard values. The power level should be adjusted according to the cookware and fill level.

Power level	Activity
1	Melting butter and chocolate, breaking up gelatine
1-3	Keeping sauces and soups warm, soaking rice
2-6	Cooking potatoes, pasta, soups and ragouts, steaming fruit, vegetables and fish, defrosting food
6-7	Frying in coated pans, moderate frying (without overheating the fat) of pork cutlets or fish
7-8	Heating up fat, browning meat, cooking thickened sauces and soups, making omelettes
9	Bringing large amounts of liquid to the boil, searing steaks
P	Heating up water

Tab. 4.5 Recommendations for power levels

Suitable cookware

Cookware with this symbol  is suitable for induction cooktops.

- Observe the minimum cookware base diameter:

Appliance	Cooking zone	Minimum cookware base diameter
M Pure	Front left	110 mm
	Rear left	90 mm
	Front right	110 mm
	Rear right	110 mm

Tab. 4.6 Minimum cookware diameter

- Place the cookware (without a mat or similar) directly onto the glass ceramic.

- i** The heating and heat-through times and cooking results are significantly influenced by the structure and material of the cookware.
- i** The cookware base must not be warped or have any sharp grooves or sharp edges. If the base is warped, the cookware may not be recognised or may overheat. Sharp grooves or edges may scratch the cooktop surface.

Noises

When operating induction cooktops, noises may occur due to material and processing of the cookware (humming, crackling, whistling, clicking or buzzing).

5 Functions and operation

- Observe all safety and warning information (see "2 Safety").

- i** The appliance should only be operated when the filter replacement cover, stainless steel grease filter and air inlet nozzle are installed (as well as the odour filter in the recirculation model).

5.1 General operating instructions

The appliance is operated via a central operating panel. The operating panel is equipped with touch zones and display zones. Operate the appliance with your finger, touch controls and swipe gestures (slider operation).

5.2 Touch control

The system recognises different touch commands.

Touch commands	Applicable to	Time (contact)
Tap	Buttons + slider	0.3 s
Long press	Buttons + slider	1-8 s

Touch commands	Applicable to	Time (contact)
Swipe	Slider	0.1–8 s

Tab. 5.1 Touch control

5.3 Operating the system

5.3.1 Switch on/off

► Long press on the power button .
Following start-up, the standard display will appear:

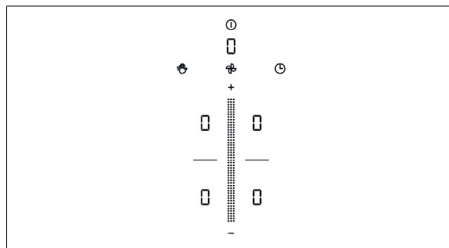





Fig. 5.1 Standard display after switching on

 When the child lock is active, the lock button lights up after system start .

5.3.2 Short-time timer





The short-time timer emits both a visual and an acoustic signal after a set time (egg-timer function).

Activating the short-time timer

► Tap the short-time timer button .
The time entered is shown in the multi-function display (□□□□).

Setting the time

► Set the desired time:

Command	Add minutes	Take away minutes
Touch		
Slider	Swipe upwards	swipe downwards
Command	Add seconds	Take away seconds
Touch	□□□	
Touch		
Slider	Swipe upwards	Swipe downwards

Tab. 5.2 Setting the time

Starting the short-time timer

► Tap the short-time timer button .
The set time starts to count down. The remaining time is shown on the multi-function display.

Time lapsed

In the last 10 seconds of the countdown, the remaining time will flash and is displayed down to the second. When the time has lapsed, you will hear an acoustic signal.

Deactivating the short-time timer early

▶ Long press on the short-time timer button .

5.3.3 Recovery function

If the appliance is switched off by accident, if switched back on within 15 seconds, the recovery function will restore the previous settings.

- ▶ Switch the appliance back on within 15 seconds.
 - The pause button will flash and the previous settings will be shown faintly.

Restoring settings

- ▶ Tap the pause button .
- The settings will be restored and started.

Declining settings

- ▶ Wait 15 seconds
- or
- ▶ long press on the pause button .
- The standard display appears.

5.4 Cooktop extractor functions

5.4.1 Fan power levels



The fan power levels can be adjusted in different ways:

- ▶ by tapping  or 
- ▶ adjustment using the slider 
- ▶ by tapping a certain position on the slider 

5.4.2 Fan power setting

When the power setting is activated, maximum extractor power is available for a predefined time. After 5 minutes, the power setting is automatically switched back to power level 9.

Activating the fan power setting

- ▶ Tap  when power level 9 is active.
-  appears in the fan display.

Deactivating the fan power setting

The fan power setting is deactivated early if another power level is set.



5.4.3 Automatic extractor function

After a brief delay, the extractor power is automatically adjusted to the highest power level used on all cooking zones that are currently in use.

Function	Power levels									
Cooking level	1	2	3	4	5	6	7	8	9	P
Extractor power	4	4	4	4	5	6	7	8	9	P

Tab. 5.3 Extractor power when automatic extractor function is active

Activating the automatic extractor function for a cooking session:



- ▶ tap the fan button .
-  is displayed.

Deactivating the automatic extractor function:

- ▶ Swipe to a fan power level.
- or
- ▶ tap the fan button .

5.4.4 Switching the fan off

Switching the fan off

- ▶ Swipe downwards to power level 0
- or
- ▶ tap  until power level 0 is reached
- or
- ▶ long press on the fan button .
- When the extractor is switched off, the automatic after-run function is activated.

5.4.5 Automatic after-run

The cooktop extractor continues to run at a lower level and switches off automatically after a defined time. The duration of the after-run function can be set in the menu (factory setting is 30 minutes).

Switching off the automatic after-run early

- ▶ Long press on the fan button .

 BORA expressly recommends use of the cooktop extractor after-run function.



5.4.6 Filter service display

The cooktop extractor filter service display is automatically activated when the end of the odour filter service life is reached (only in recirculation mode).

-  is displayed in the multi-function display.
- The cooktop extractor can still be operated without limitations.

5.5 Cooktop functions

5.5.1 Pan size recognition

On induction cooktops the cooking zone recognises the size of the cookware automatically and only targets the energy at that area. An induction cooking zone is not working if the display alternates between  / .

Possible causes:

- Missing cookware
 - Unsuitable cookware
 - The base diameter of the cookware is too small
- If no pot is detected 10 minutes after setting a power level, the cooking zone will switch off automatically.

Permanent pan size recognition

The appliance automatically recognises cookware and activates the corresponding cooking zone controls.

Manual selection of the cooking zone is not necessary (Menu item 7: Permanent pan size recognition).

i Do not simply rely on the pan size recognition function on induction cooktops; always switch the appliance off after use.



5.5.2 Selecting a cooking zone

▶ Tap a cooking zone display.

Cooking zone operation is activated and settings can be made until the operating panel switches to the standard display.

5.5.3 Setting cooking zone power levels

After selecting the cooking zone, the power level can be set in 3 different ways:

- ▶ by swiping until you reach the required power level or
- ▶ by tapping a certain position on the slider or
- ▶ by tapping  or .

Repeat this process to operate further cooking zones if necessary.

i The power level set is shown in the respective cooking zone display.



i Five seconds after the power level is changed, the operating panel display automatically returns to the standard display.

5.5.4 Cooking zone power setting

When the power setting is activated, maximum cooking zone power is available for a cooking zone. After 5 minutes, the power setting is automatically switched back to power level 9. For the second cooking zone on the same side, the maximum power is temporarily reduced.

i If the power level is set too high on the second cooking zone, the power setting will be automatically disabled on the other cooking zone.

Activating the power setting for a cooking zone

- ▶ Tap  when power level 9 is active.
-  appears in the cooking zone display.

Deactivating the power setting early

- ▶ Setting another power level



i Never heat up oil, fat and the like on the power setting. The bottom of the pan can overheat due to the high power output.

5.5.5 Cooking zone timer

This automatic cut-off function automatically switches off the selected cooking zone once a preset time has lapsed. The cooking zone timer function can also be used on several cooking zones at the same time (multi-timer).





Activating cooking zone timers

Prerequisite: Cooking zone is active (power level is set).

- ▶ Tap the timer button .
- The time entered is shown in the multi-function display (.

Setting the time

- ▶ Set the desired time:

Command	Add minutes	Take away minutes
Touch		
Slider	Swipe upwards	swipe downwards
Command	Add seconds	Take away seconds
Touch		
Touch		
Slider	Swipe upwards	Swipe downwards

Tab. 5.4 Setting the time

Starting the timer

- ▶ Tap the flashing timer button .
- The set time starts to count down. The remaining time is shown on the multi-function display.

Showing the remaining time

- ▶ Tap the cooking zone display with an active cooking zone timer.
 - The remaining time is shown in the multi-function display.

Changing active timers

- ▶ Tap the cooking zone display with an active cooking zone timer.
- ▶ Tap the timer button .
 - The cooking zone timer is stopped.
 - The remaining time flashes in the display.
- ▶ Change the set time and restart the cooking zone timer.

Multi-timer

- ▶ Repeat the process for additional cooking zones.

Switching the timer off early

- ▶ Tap the cooking zone display with an active cooking zone timer.
- ▶ Long press on the timer button .

Time lapsed

In the last 10 seconds of the countdown, the remaining time will flash and is displayed down to the second. At the end of the set time, an acoustic signal is heard and the cooking zone is automatically switched off (= power level .

5.5.6 Pause function

With the pause function all cooking zones can be quickly and easily deactivated temporarily. The cooking processes can be interrupted for a maximum of 10 seconds. If the pause function is deactivated, operation will resume with the original settings. Once 10 minutes have lapsed, the cooking session is automatically ended.

-  The fan function, the bridging function and the (active) minute minder cannot be interrupted. Active cooking zone timers are stopped.

Activating the pause function

- ▶ Tap the pause button .

Deactivating the pause function



- ▶ Long press on the pause button .

5.5.7 Variable heat retention function

You can choose from 3 heat retention levels according to the situation:

Heat retention level	Symbol	Temperature
1 (melt)	—	≈ 40 °C
2 (keep warm)	—	≈ 75 °C
3 (simmer)	—	≈ 95 °C



Tab. 5.5 Heat retention levels

-  In practice the temperatures of the heat retention levels may vary slightly as they are influenced by different factors.
-  This function is designed for use with cookware lids. To maintain the specified temperatures, a cookware lid must be used.

Activating the heat retention function

- ▶ Selecting a cooking zone
- ▶ Tap the heat retention button .

Increasing or reducing the heat retention level

- ▶ Swipe to reach the required heat retention level or
- ▶ tap  or  until the required heat retention level is reached
- ▶ Tap the heat retention button  to confirm.

Deactivating the heat retention function

- ▶ Tap the corresponding cooking zone display.
 - ▶ Long press on the heat retention button .
- or
- ▶ swipe right down to the bottom (power level 0).
 - The heat retention function is deactivated.

5.5.8 Bridging function

-  Function only available with the 2 surface induction cooking zones on the right.

With the bridging function, two cooking zones located one behind the other can be combined to form one large cooking zone. The power for the combined zones is then adjusted by a single operating control. Power adjustment takes place simultaneously (both cooking zones are operated on the same power level). The bridging function is suitable for heating food, e.g. in a roaster.

i If both cooking zones are active before the bridging function is activated, the lower power level is adopted. If timers are active on the cooking zones, the lower timer value will be adopted for the bridging timer.

i The bridging function finishes and the cooking zones are deactivated if no suitable cookware is detected (pan size recognition) on any or only one of the two cooking zones for 10 seconds.

Activating the bridging function

- ▶ Tap the bridging button
- Both cooking zone displays show the same power level.
- Active additional cooking zone functions are adopted (dual display).

Deactivating the bridging function

- ▶ Long press on the bridging button.
- or
- ▶ long press on one of the two cooking zone displays.
 - The power levels are set to 0.
 - If a cooking zone timer was active, it is deactivated.

5.5.9 Automatic bridging function

If a large enough piece of cookware is placed on the two cooking zones that are one behind the other, they will automatically be combined to form one large cooking zone.

i If the permanent pan size recognition function is switched on (Menu item 7: Permanent pan size recognition), the automatic bridging function is also activated.

5.5.10 Switching off the cooking zone

- ▶ Selecting a cooking zone
 - ▶ Set power level to 0
- or
- ▶ long press on the cooking zone display

5.6 Safety features

5.6.1 Child lock

The child lock prevents the appliance from being switched on accidentally. If the child lock is active, the lock button  will light up in the operating panel display.

Permanently activating/deactivating the child lock

(User menu)

Deactivating the child lock for a cooking session

- ▶ Long press on the lock button .

5.6.2 Cleaning lock

The cleaning lock blocks the operating panel. If no wiping motions are detected on the operating panel, the cleaning lock will automatically deactivate after 5 seconds.

Activating the cleaning lock

- ▶ Tap the cleaning button .

Prematurely deactivating the cleaning lock

- ▶ long press on the cleaning button .

5.6.3 Residual heat indicator

If a cooking zone is still hot after switching off, H is displayed.

- ▶ Do not touch hot cooking zones.
- ▶ Do not place any objects on the cooking zones while hot.

The display goes out after a sufficient cooling time (temperature < 55°C).

5.6.4 Safety shut-down





Cooktop extractor

The cooktop extractor switches to automatic mode after 120 min if there has been no input or changes to the power level.

Cooktops

Each cooking zone is automatically switched off after a predefined operating time in which the power level has not been changed. The period of time until safety shut-down is triggered can be set in the customer menu.

Power level	Safety shut-down after hrs:min.		
	Level 1	Level 2	Level 3
1	12:00	8:24	6:00
2	10:00	6:24	4:00
3	9:00	5:12	2:30
4	8:00	4:12	2:00
5	6:00	3:18	1:30
6	4:00	2:12	1:00

Power level	Safety shut-down after hrs:min.		
	4:00	2:12	1:00
	3:00	1:48	0:45
	2:00	1:18	0:30
	0:05	0:05	0:05

Tab. 5.6 Safety shut-down on the different power levels

Heat retention level	Safety shut-down after hrs:min.		
	Level 1	Level 2	Level 3
	12:00	8:00	4:00

Tab. 5.7 Safety shut-down on the different heat retention levels

5.6.5 Overheating protection

In the event of overheating, the cooktop power is reduced or the appliance is switched off completely.

The overheating protection is triggered when:

- cookware is heated up empty;
- oil or fat is heated on high power;
- a hot cooking zone is switched on again after a power cut.

Whilst the overheating protection is active, one of the following steps is taken:

- the activated power setting is switched back to the previous level;
- the power setting can no longer be activated;
- the set power level is reduced;
- the cooktop switches off completely.

After a sufficient cooling period, the cooktop can be used again in full.

6 Connect

6.1 Installing the app

The BORA JOY app is free to download from the Google Play Store™ or Apple App Store®.

- ▶ Install the BORA JOY app on your smartphone.



6.2 Account

Only one smartphone at a time can be linked to the appliance via the BORA JOY app.

The appliance can only be linked to one BORA JOY account. If the appliance is linked to more than one smartphone, the BORA JOY app on all smartphones must be linked to the same BORA JOY account.

Customers cannot restore the link between appliances and accounts. If you need to create a link to a new BORA JOY account, contact the BORA Service Team.

6.3 Pairing

- ▶ Activate connectivity in the customer menu (User menu).
- The Connect button  should be only faintly lit.
- ▶ Open the BORA JOY app on your smartphone.
- ▶ Select the desired BORA appliance and start connection.
- The Connect button will fade in and out.
- ▶ Tap the Connect button  to confirm the connection.
- The Connect button will light up fully.
- If the connection is interrupted, the Connect button will be dimmed again.

6.4 BORA JOY app

Certain settings and programmes can be selected, customised and started using the BORA JOY app.

- ▶ Adjust the settings in the app. To do this, follow the instructions in the app.
- ▶ Select "Transfer settings".
- The Assist button on the operating panel will fade in and out.
- ▶ Tap the Assist button  to confirm the setting.
- The settings are transferred.

7 BORA Assist

- ▶ Observe all safety and warning information (see "2 Safety").

BORA Assists are programmes designed to help you with certain dishes and cooking processes.

7.1 Cookware

The BORA Assist functions can only be used with the specially designed cookware:

www.bora.com/cookware-recommendations

- ▶ When starting BORA Assist, use only cookware and water at room temperature.

7.2 BORA Assist

Two Assist functions are available on the appliance:





- Fry – accurate frying to the last degree
- Boil – for boiling water

7.2.1 Allocating Assists using the BORA JOY app

- ▶ Select the desired Assist in the BORA JOY app.
- ▶ Select “Transfer selection”.
- ▶ Tap the Assist button  to confirm the transfer.



7.3 Activating BORA Assist

Only one Assist can be used on each side of the appliance.

- There must be no residual heat displayed at the desired cooking zone.
- ▶ Tap the desired cooking zone display
- ▶ Tap the Assist button .
- ▶ Select the desired Assist using the slider or the +/- button.
- ▶ Tap the Assist button  to confirm the selection.
-  is shown in the cooking zone display with the Assist icon beside it.
- The heating-up animation appears in the slider or  flashes in the cooking zone display.
- If manual cooking processes are required, the cooking zone display will fade in and out. If the necessary cooking processes have been completed, the Assist requires confirmation in order to continue.
- ▶ Tap the cooking zone display.
- ▶ Tap the Assist button  to confirm the next step





7.3.1 Adjusting the cooking programme

When Assists are active, it is possible to slightly adjust the power level. You can increase or decrease the level by one digit.

- ▶ Tap the cooking zone display with the active Assist.
- ▶ Adjustment using the slider or  /  button

7.3.2 Fry – accurate frying to the last degree

Assist Fry enables you to set frying temperatures from 120–220 °C in 20 °C increments. This function is designed for Assist-compatible frying pans.

- ▶ Tap the cooking zone display with the active programme.
- ▶ Using the slider  or  /  button, set the desired frying temperature.
- The temperature is shown in °C in the multi-function display.
-  flashes in the cooking zone display until the target temperature is reached for the first time and an acoustic signal is heard.

Activity	Temperature in °C
Stewing fruit and vegetables	120 - 140
Fried eggs, omelette, scrambled egg	140 - 160
Desserts containing flour, pancakes, blinis, Kaiserschmarrn	160 - 180
Frying meat, grilled vegetables, breaded food (fish, escalopes, vegetables), frying fruit	180 - 200
Frying steak, prawns, fish fillets, fried potatoes	200 - 220

Tab. 7.1 Temperature recommendations (the specifications provided in the table are standard values)





7.3.3 Boil – for boiling water

The Assist Boil programme enables you to boil water.

- ▶ Fill the Assist-compatible cookware with water to a depth of 6 to 8 cm (regardless of the pan size).
- ▶ Start the Assist Boil programme.
 - The cooking zone deactivates automatically when the water boils and an acoustic signal is heard.

7.3.4 Adjusting the cooking zone timer

Cooking zone timers can be adjusted manually.

- ▶ Tap the cooking zone display with the active Assist programme.
- ▶ Tap the timer button .
- ▶ The time can be adjusted using the slider  or  /  button.

7.4 Starting BORA Assist using the BORA JOY app

Assists that have not been saved on the appliance can only be started using the BORA JOY app.

- ▶ Select the Assist in the BORA JOY app.
- ▶ Select “Start programme” in the BORA JOY app.
- ▶ Tap the Assist button  to confirm the special programme.

7.5 Switching BORA Assist off early

Assists can always be switched off early.

- ▶ Tap the cooking zone display with the active Assist programme.
- ▶ Long press on the Assist button  or
- ▶ long press on the cooking zone display.

7.6 Completion of a BORA Assist

Depending which BORA Assist has been activated, it will be deactivated once the timer lapses or must be switched off manually.

7.6.1 Extending the time

When the Assist time has ended, it can be manually extended.

- ▶ Tap the cooking zone display in which the Assist function has stopped.
- The 1-minute cooking zone timer will be suggested in the multi-function display.
- The cooking zone timer can be adjusted manually.
- ▶ Tap the Assist button .
- The Assist programme will be extended.

8 User menu

Calling up the user menu

Prerequisite: the appliance is switched on, all cooking zones and the cooktop extractor are inactive and there is no residual heat.

- ▶ Long press on the multi-function display.

Navigating the user menu

Navigate to the next menu item:

- ▶ Tap the multi-function display.
- Any changed settings are automatically applied when changing to another menu item or when exiting the menu.

Closing the user menu

- ▶ Long press on the multi-function display.
- or
- ▶ long press on the power button .
- The menu is closed and the appliance is switched off.

User menu overview

Menu item/Description/Selection	Factory setting
Con Connectivity	Off
1 Volume of the acoustic signals (0-9)	0
2 Child lock (On/Off)	Off
3 Show filter status (reset filter service display)	
4 Duration of the automatic after-run function (40, 30, 20 min.)	30 min
5 Touch zone reaction speed (1 slow, 2 medium, 3 fast)	2
6 LED test	

Menu item/Description/Selection	Factory setting
7 Permanent pan size recognition	Off
8 Software/hardware version	
9 Safety shut-down (1 long, 2 medium, 3 short)	2
0 Reset to factory settings	

Tab. 8.1 User menu overview

8.1 Menu item Con: connectivity

The connectivity function can be permanently activated or deactivated.

- ▶ Tap the top slider segment  to activate.
- ▶ Tap the bottom slider segment  to deactivate.

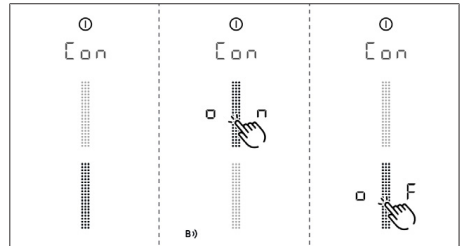

Fig. 8.1 Menu item Con: connectivity

8.2 Menu item 1: volume of the acoustic signals

It is possible to set different acoustic signal volume levels. This does not apply to safety-relevant acoustic signals.

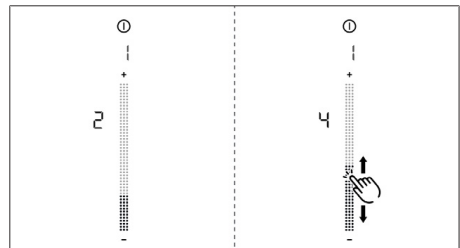

Fig. 8.2 Menu item 1: Volume of the acoustic signals

8.2.1 Sounds

The system distinguishes between different signal acoustic signals:

Acoustic signal	Purpose
Short beep (0.25 s)	Confirmation of a selection
Sequence of beeps	Interaction required

Tab. 8.2 Sounds

8.3 Menu item 2: Child lock

The child lock can be permanently activated or deactivated.

- ▶ Tap the top slider segment  to activate.
- ▶ Tap the bottom slider segment  to deactivate.

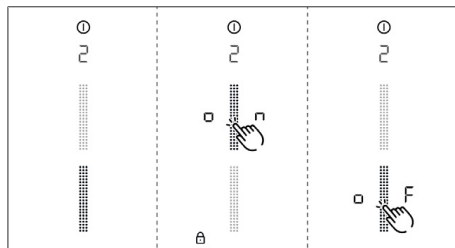



Fig. 8.3 Menu item 2: Child lock

8.4 Menu item 3: Show filter status and reset filter service display

- ▶ Long press on .
- The filter status will be reset to 100%.
- The filter service display  will no longer be shown when switching on.

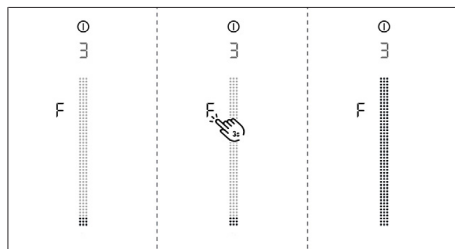

Fig. 8.4 Menu item 3: Reset filter status and the filter service display

8.5 Menu item 4: Duration of the automatic after-run function

There are three times to choose from:
40 minutes / 30 minutes / 20 minutes

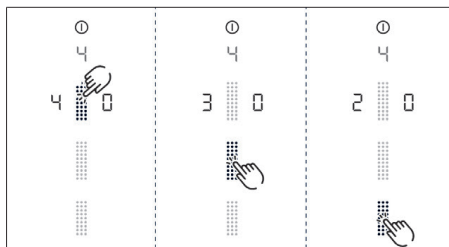





Fig. 8.5 Menu item 4: Selecting the duration of the automatic after-run function

8.6 Menu item 5: Touch zone reaction speed

- ▶ Select the required reaction speed.
- Reaction speed : slow
- Reaction speed : medium
- Reaction speed : fast

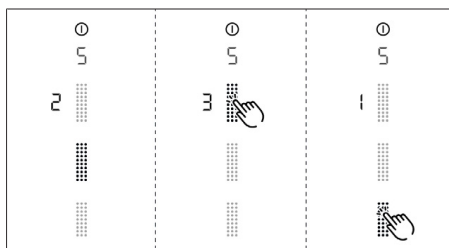



Fig. 8.6 Menu item 5: Reaction speed

8.7 Menu item 6: LED test

- ▶ Tap the slider zone .
- All indicators are displayed at 50% brightness.
- ▶ Tap any indicator you wish.
- The selected indicator will be displayed at 100% brightness for 1 second for testing purposes.

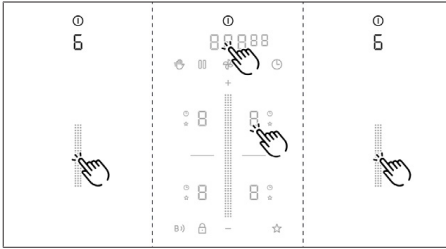

Fig. 8.7 Menu item 6: LED test

Ending the LED test:

- ▶ Long press on the multi-function display.
- The LED test will be automatically ended when there has been no activity for 5 seconds.

8.8 Menu item 7: Permanent pan size recognition

Activate or deactivate permanent pan size recognition.

- ▶ Tap the top slider segment  to activate.
- ▶ Tap the bottom slider segment  to deactivate.

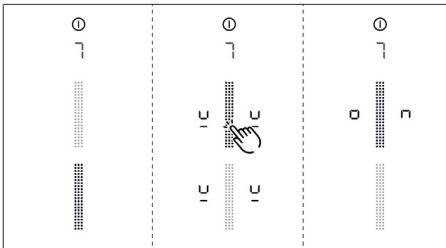

Fig. 8.8 Menu item 7: Permanent pan size recognition

8.9 Menu item 8: Show software/hardware version

The software/hardware version is shown via the four 4 cooking zones indicators.

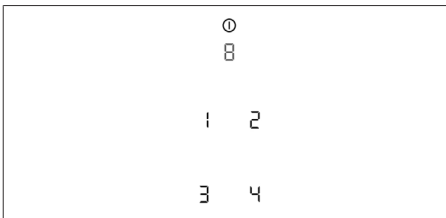

Fig. 8.9 Menu item 8: Software/hardware version

8.10 Menu item 9: Safety shut-down

The time span (level) until automatic safety shut-down of the cooking zones can be selected.

- Level 1: long time span until automatic safety shut-down
- Level 2: medium time span until automatic safety shut-down (factory setting)
- Level 3: short time span until automatic safety shut-down

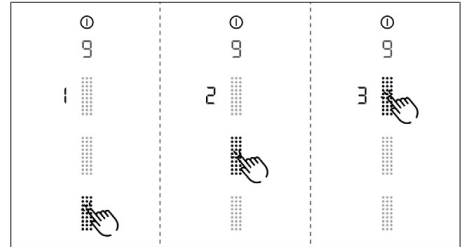



Fig. 8.10 Menu item 9: Safety shut-down

8.11 Menu item 0: Reset to factory settings

-  Menu item 0 enables all settings in the user menu to be reset to the factory settings.

Resetting to factory settings

- ▶ Long press on the slider zone .
- After resetting, the appliance is switched off.

9 Cleaning and maintenance

- ▶ Observe all safety and warning information (see "2 Safety").
- ▶ When conducting cleaning and maintenance, ensure that the cooktop and cooktop extractor are fully switched off and cooled so as to prevent injury.
- ▶ Adhere to the following cleaning and maintenance cycles:

Component	Cleaning and maintenance cycles
Operating panel	Immediately after every soiling
Cooktop	Immediately after every soiling
Cooktop extractor	Weekly

Component	Cleaning and maintenance cycles
Air inlet nozzle and stainless steel grease filter	After cooking very greasy dishes, but at least once a week If the filter service indicator F appears
Air guiding housing	Every 6 months or when replacing the odour filter
Odour filter (recirculation only)	Replace if odours have built up, extraction power is dwindling or the filter service indicator F appears

Tab. 9.1 Cleaning cycles

i Regular cleaning and maintenance ensures long service life of the product and optimal function.

9.1 Cleaning agents

- ▶ Do not use any chemically aggressive cleaning agents or agents containing acid or lye (e.g. oven spray).
- ▶ Make sure that the cleaning agent does not contain any sand, soda, acids, lyes or chloride.
- ▶ Never use a steam cleaner, abrasive sponges or scouring pads.

i Aggressive cleaning agents and abrasion caused by the pot bases will damage the surface and dark stains will occur.

9.2 Maintenance

- ▶ Never use the cooktop as a work or storage surface.
- ▶ Do not push or pull cookware over the cooktop.

Any changes in colour or glossy spots do not mean that the cooktop is damaged. They do not affect the functionality of the cooktop or the stability of the glass ceramic panel.

Changes in the colour of the cooktop are the result of residues which have not been removed and have burnt on.

Glossy spots are the result of wear by the pan base, especially if soft cookware materials or unsuitable cleaning agents are used. Always lift (do not drag) cookware to prevent scratching and abrasion on the appliance surface. These are difficult to remove.

9.3 Cleaning the cooktop

i To clean the cooktop, you need a special glass ceramic scraper and suitable cleaning agents.

Scheduled cleaning

- ▶ Remove all coarse dirt and food residues from the cooktop using a glass ceramic scraper.
- ▶ Apply the cleaning agent to the cold cooktop.
- ▶ Spread the cleaning agent using kitchen roll or a clean cloth.
- ▶ Wipe the cooktop clean with a damp cloth.
- ▶ Dry the cooktop with a clean cloth.

Heavy soiling

- ▶ Remove heavy soiling and marks (limescale marks, mother-of-pearl-like shiny marks) using cleaning products while the cooktop is still warm.
- ▶ Wipe off any food that boils over with a damp cloth.
- ▶ Remove any remaining dirt with the glass ceramic scraper.

Surface cleaning during operation

- ▶ Always remove any seeds, crumbs or similar immediately to avoid scratching the surface.
- ▶ Remove stubborn residues of plastic, aluminium foil, sugar or sweet dishes from the hot cooking zone immediately using a glass ceramic scraper to prevent burning.

9.4 Cleaning the cooktop extractor

- ▶ Clean the surfaces of the extraction system using a soft, damp cloth, detergent or a mild window cleaning agent.
- ▶ Soften dried on dirt using a damp cloth (do not scrape it off!).

9.4.1 Cleaning the air inlet nozzle and stainless steel grease filter

i The air inlet nozzle and stainless steel grease filter absorb the greasy particles from cooking vapours.

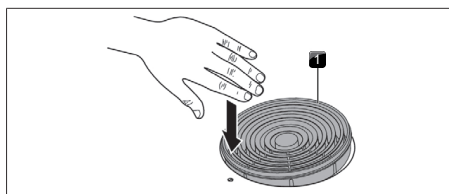

Fig. 9.1 Removing the air inlet nozzle

[1] Air inlet nozzle

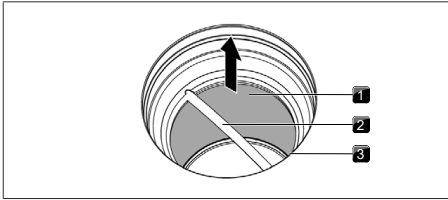

Fig. 9.2 Removing the stainless steel grease filter

- [1] Stainless steel grease filter
 [2] Handle
 [3] Inlet opening

Manual cleaning

- ▶ Use a cleaner and degreaser in one.
- ▶ Rinse the components with hot water.
- ▶ Clean the components with a soft brush.
- ▶ Rinse the components in clean water after cleaning.

Cleaning in the dishwasher

- ▶ Place the components in the dishwasher in such a way that water cannot accumulate inside then.
- ▶ Select a rinse programme with a maximum temperature of 65 °C.

- i** The stainless steel grease filter must be replaced when it can no longer be fully cleaned. (see "13 Warranty, technical service, spare parts, accessories").

Fitting the components

- ▶ To install the components, follow the steps in reverse order.

- i** Only insert dry, clean components inside the appliance.

9.4.2 Removing liquids from the appliance

- i** Any liquids that flow into the appliance through the inlet opening are caught by the stainless steel grease filter (up to 150 ml) and in the air guiding housing.

Do the following:

- ▶ Remove the air inlet nozzle and stainless steel grease filter.
- ▶ Empty the stainless steel grease filter.
- ▶ Check whether any liquid has gathered in the base of the air guiding housing.
- ▶ Remove the liquid from the air guiding housing.

- ▶ To dry the odour filter and duct parts, switch on the cooktop extractor at a minimum power level of 5.
- After 120 minutes, the cooktop extractor will automatically switch off and the automatic after-run function will be activated.

9.5 Cleaning the air guiding housing

The air guiding housing can be found on the bottom of the cooktop inside the floor unit. Grease particles and limescale residues can settle on the surface of the air guiding housing.

Opening the air guiding housing

- ▶ Remove the air inlet nozzle and stainless steel grease filter.
- ▶ Remove the filter replacement cover.
- ▶ Release the 6 locks around the edge of the base.
- ▶ Remove the housing base.
- ▶ Clean the air guiding housing and the housing base with a mild cleaning agent.

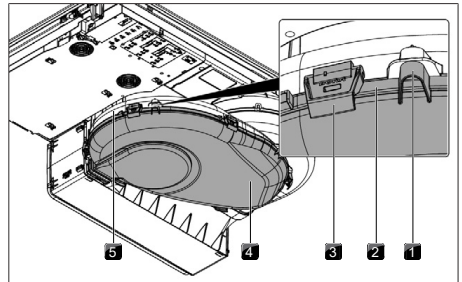



Fig. 9.3 Air guiding housing

- [1] Spigot
 [2] Sealing groove
 [3] Lock
 [4] Housing base
 [5] Air guiding housing

Closing the air guiding housing

- ▶ Position the housing base with the help of the 3 spigots around the edges.
- ▶ Push the housing base upwards into the sealing groove.
- ▶ Close the 6 locks.
- ▶ Check that the housing base is positioned correctly.
- ▶ Insert the filter replacement cover.
- ▶ Check that the filter replacement cover is positioned correctly.
- ▶ Insert the stainless steel grease filter and the air inlet nozzle.

9.6 How to replace the odour filter

- i** The odour filter (activated charcoal filter) must be replaced when the fan indicator is shown  (filter service display). You can obtain filters from your specialist retailer or from the BORA shop via the website at shop.bora.com.

How to remove the odour filter

- ▶ Remove the air inlet nozzle and stainless steel grease filter.
- ▶ Inside the inlet opening pull the filter replacement cover out through the opening in the filter housing.

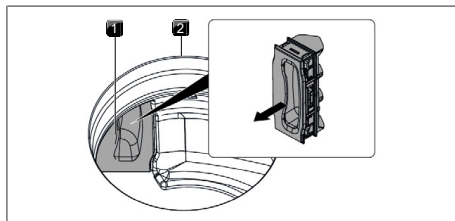

Fig. 9.4 How to remove the filter replacement cover

- [1] Filter replacement cover [2] Air inlet opening

- ▶ Take hold of the odour filter by the grip strap and pull it out as far as possible.

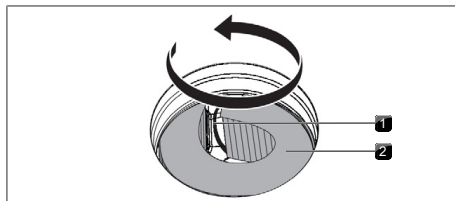

Fig. 9.5 Twist the odour filter out of the filter housing

- [1] Grip strap [2] Odour filter

- ▶ Pull the odour filter upwards and twist to take it out of the air inlet opening.

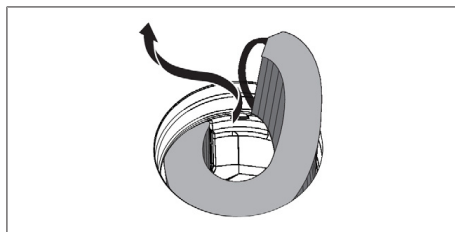

Fig. 9.6 How to remove the odour filter through the inlet opening

How to fit the odour filter

- ▶ Remove the packaging.
- ▶ Position the odour filter correctly with the help of the printed symbols (arrow left, grip strap right, 'TOP' facing upwards).
- ▶ Hold the odour filter at both ends.
- ▶ Bend the odour filter to form a cylinder.

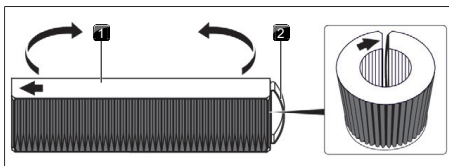

Fig. 9.7 Odour filter

- [1] Top of odour filter [2] Grip strap

- ▶ Tilt the odour filter slightly and insert it through the air inlet opening.

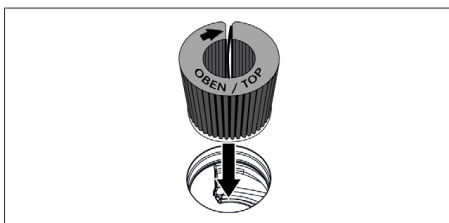

Fig. 9.8 How to insert the odour filter through the extractor opening

- ▶ Guide the left end of the filter into the opening in the filter housing.
- ▶ Push the odour filter into the filter housing until it will go no further (to do this, you can place one finger between the slats and gradually push the filter into the housing).
- The end position of the odour filter is reached when the filter has been fully pushed inside the filter housing.

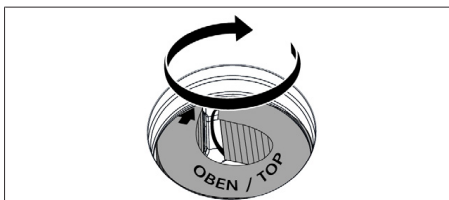

Fig. 9.9 How to place the odour filter in the end position

- ▶ Reinsert the filter replacement cover and check that it is in the correct position.

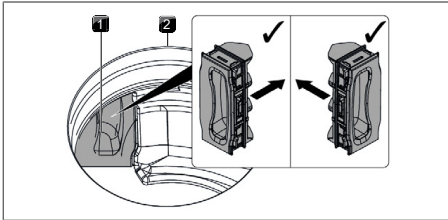

Fig. 9.10 How to insert the filter replacement cover



[1] Filter replacement cover [2] Air inlet opening

- ▶ Insert the stainless steel grease filter and the air inlet nozzle.
- ▶ Reset the filter service display (menu item 3: Show filter status and reset filter service display).

10 Troubleshooting

i You can often remedy faults and errors yourself. This saves time and money as you don't need to call out customer services.

► Observe all safety and warning information (see "2 Safety").

Operating situation	Cause	Remedy
Appliance cannot be switched on	Fuse/automatic circuit breaker defective	Replace the fuse; Switch the automatic circuit breaker back on
	The fuse/automatic circuit breaker trips several times	BORA Contact the Service Team.
	The power supply is disconnected	Have a specialist electrician inspect the power supply
Odour formation when operating a new appliance	This is normal with brand new appliances	Odours stop forming after a few operating hours
A cooking zone display shows 	No or unsuitable cookware	Use suitable, appropriately sized cookware (see "Appliance description")
The lock button lights up 	Active child lock	deactivate the child lock
Cooking zone/cooktop switches off automatically	The maximum cooking zone operating time has been exceeded	Put the cooking zone back into operation
Power setting prematurely cancelled	The overheating protection has tripped	see "5.6.5 Overheating protection"
The cooktop cooling fan continues to run when the cooktop has been switched off	The cooling fan runs until the cooktop has cooled	Wait until the cooling fan switches off automatically
Decreased extraction performance of the cooktop extractor	Grease filter extremely dirty	Clean or replace the grease filter
	Odour filter extremely dirty (recirculation only)	Replace the odour filter
	Item in air guiding housing (e.g. cleaning cloth)	Remove the object
E or EB is displayed	Use of a phase-separating window contact switch	Open the window
	Fan defective or a duct connection has become loose	BORA Contact the Service Team
E2 is displayed	The overheating protection has tripped	see "5.6.5 Overheating protection"
E03 is displayed	Object on the operating panel	Remove the object from the operating panel
	The operating panel is dirty	Clean the operating panel
F is shown (recirculation only)	End of odour filter (activated charcoal filter) service life reached	Fit a new odour filter (see "9.6 How to replace the odour filter").

Tab. 10.1 Troubleshooting

Faults and errors not covered:

- Switch off the appliance.
- Contact the BORA Service Team (see "13 Warranty, technical service, spare parts, accessories") and enter the error number displayed and the appliance type.

11 Installation

- Observe all safety and warning information (see "2 Safety").

11.1 General installation instructions

- i** The power supply cable must be provided by the customer.
- i** The appliance must not be installed above cooling devices, dishwashers, stoves, ovens, washing machines or dryers.
- i** The contact surfaces of the worktops and wall sealing strips must be made of a heat-resistant material (up to approx. 100 °C).
- i** Worktop cut-outs must be moisture-sealed using suitable means and, where necessary, fitted with a thermal insulator.
- i** The integrated cooktop extractor must not be used with other cooktops.
- i** To maintain the level of performance and avoid overheating, sufficient ventilation must be ensured below the cooktops.
- i** If cable protection (false floor) is planned beneath the appliance, this must be fitted so it does not obstruct ventilation.

11.1.1 Simultaneous operation of the cooktop extractor in the exhaust air mode with a fireplace dependent upon the air supply in the room

Fireplaces that depend on the air in the room (e.g. gas, oil, wood or coal-fired heaters, continuous-flow water heaters, instantaneous water heaters) draw in air from the room in which they are installed and release the exhaust fumes into the outside air via an exhaust system (e.g. chimney).

If the cooktop extractor is used in exhaust air mode, it draws in air from the room in which it is installed as well as from neighbouring rooms. Without sufficient air, there will be a drop in air pressure. Toxic gases could be drawn out of the chimney or extraction ducting and back into the room.

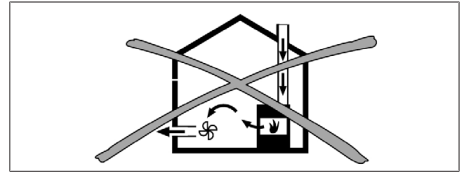

Fig. 11.1 Exhaust air installation – not permitted

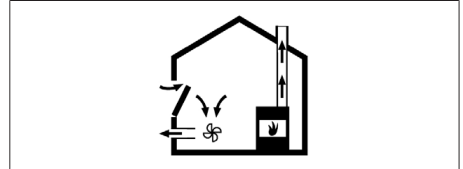

Fig. 11.2 Exhaust air installation – correct

- If simultaneously operating both the cooktop with a fireplace and the cooktop extractor in the room they are installed, ensure that...
- ...the maximum low pressure is 4 Pa;
 - ...a safety device (e.g. window contact switch, low pressure warning device) is used to ensure that a sufficient supply of fresh air is guaranteed;
 - ...the exhaust air is not channelled into a chimney that is used for exhaust gases of appliances operated with gas or other combustibles;
 - ...the installation is checked and approved by an authorised certified engineer (e.g. heating engineer).
- i** If the cooktop extractor is used exclusively in recirculation mode, simultaneous operation with a fireplace dependent on the air in the room is possible without any additional safety measures.

11.2 Scope of delivery

Scope of delivery	Quantity
Cooktop with integrated cooktop extractor	1
Air inlet nozzle	1
Stainless steel grease filter	1
Operating and installation instructions	1
Installation clamps	4
Sealing tape	1
Height adjustment plate set	1
Bag containing various small parts for assembly	1
additional scope of delivery for PURMU2 / PURMU2R	
Odour filter (activated charcoal filter)	1
Template for back panel cut-out	1

Tab. 11.1 Scope of delivery

Checking the scope of delivery

- ▶ Make sure the delivery is complete and check it for damage.
- ▶ Immediately notify the BORA Service Team if parts are missing or damaged.
- ▶ Do not under any circumstances install parts which are damaged.
- ▶ Dispose of transport packaging in the proper manner (see "12 Decommissioning, disassembly and disposal").

11.3 Tools and aids

The following tool, among others, is required to correctly install the appliance:

- Jigsaw or handsaw
- size 20 Torx screwdriver key
- black, heat-resistant silicone sealant
- Template for cut-out on back panel (recirculation only)

11.4 Assembly instructions

11.4.1 Installation clearances

- ▶ Observe the required clearance around the worktop cut-out.

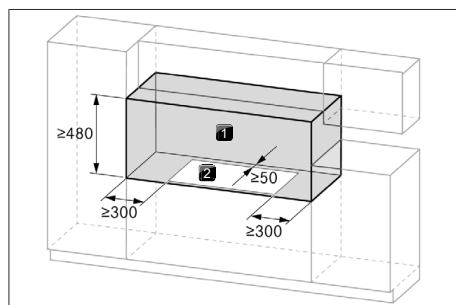

Fig. 11.3 Required clearance

[1] Required clearance [2] Worktop cut-out

11.4.2 Minimum unit dimensions

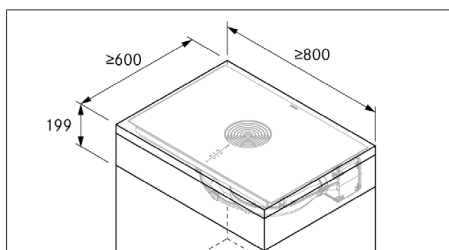

Fig. 11.4 Minimum unit dimensions

11.4.3 Information on kitchen units

- Cross bars on the kitchen unit in the area of the worktop cut-out may need to be removed.
- In the case of thin worktops, there must be a sufficiently rigid support plate on the unit.
- The drawers and/or shelves in the floor unit must be removable.
- The drawers of the floor unit must be shortened depending on the installation situation.

If false floor (cable protection) is planned, the following must be taken into account:

- It must be fitted in such a way that it can be removed from below for maintenance work.
- To ensure sufficient cooktop ventilation, a minimum distance of 15 mm to the bottom edge of the cooktop is to be observed.

11.5 Worktop cut-out

i The minimum measurement of 50 mm from the front edge of the worktop to the worktop cut-out is a recommendation from BORA.

- ▶ Create the worktop cut-out taking into account the specified cut-out dimensions.
- ▶ Make sure that the cut surfaces of the worktops are properly sealed.
- ▶ Comply with the instructions of the worktop manufacturer.

11.5.1 Cut-out dimensions

Flush installation

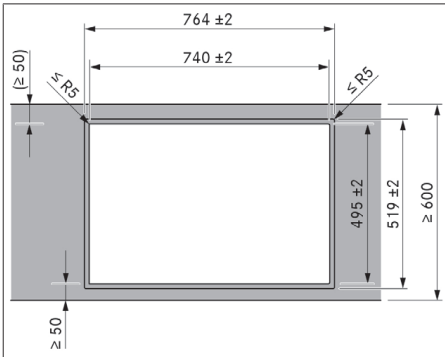

Fig. 11.5 Cut-out dimensions for flush installation

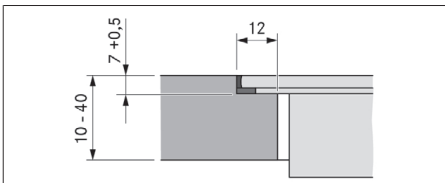

Fig. 11.6 Rebate dimensions for flush installation

Surface mounting

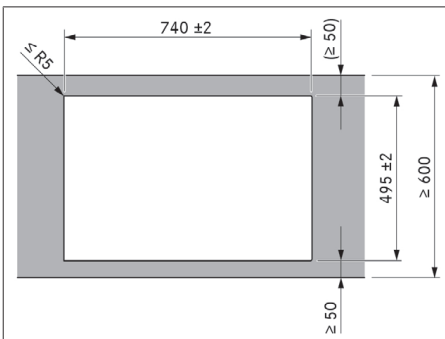

Fig. 11.7 Cut-out dimensions for surface mounting

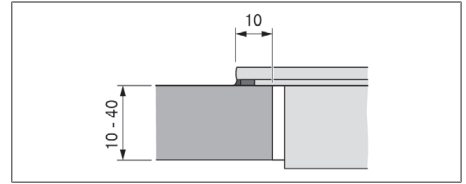

Fig. 11.8 Overlay dimensions for surface mounting

11.6 Preparing kitchen units for exhaust air models

- i** National and regional laws and regulations must be observed with regard to the exhaust duct design.
- i** A sufficient air supply must be ensured.
- i** The exhaust air must be directed to the outside by appropriate exhaust air ducts.
- i** The minimum cross section of the exhaust air duct must be 176 mm^2 which equates to a round pipe with a diameter of 150 mm or the BORA Ecotube duct system.
- i** As a general rule, with the built-in fan, a length of duct of up to 6 metres with six 90° bends, 8 metres with four 90° bends or 10 metres with two 90° bends can be installed.
- i** Not compatible with BORA Universal fans.
- i** Planning instructions for the installation of the exhaust air ducts are provided in the BORA planning guide.

11.6.1 Adapting kitchen units

- The back panel of the floor unit must be adapted for the exhaust air duct.
- A clearance of 120 mm must be provided behind the rear panel of the unit for the exhaust air duct.
- No false floor is necessary below the cooktop.

Adjusting the back panel of the unit

- Before installation, check the suitability of the floor unit with regard to the necessary installation dimensions for the appliance and the planned duct system.
- If necessary, adjust the position of the back panel according to the required installation dimensions.

11.6.2 Installation dimensions

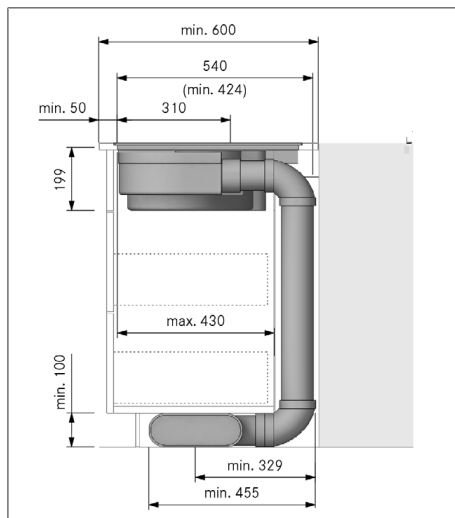

Fig. 11.9 Installation dimensions for exhaust air, worktop depth 600 mm

11.7 Preparing kitchen units for recirculation models

11.7.1 Recirculation of air from the kitchen unit

In the case of recirculation systems, a return flow aperture must be provided in the kitchen unit to guide the clean recirculated air out of the unit and back into the room. The return flow aperture can be created above a shortened plinth. A slatted plinth with at least the minimum opening cross-section can also be used.

- ▶ Decrease the height of the plinth panel or create corresponding openings in the plinth.
- ▶ The cross-section of the return flow aperture must be $\geq 500 \text{ cm}^2$ for each cooktop extractor.

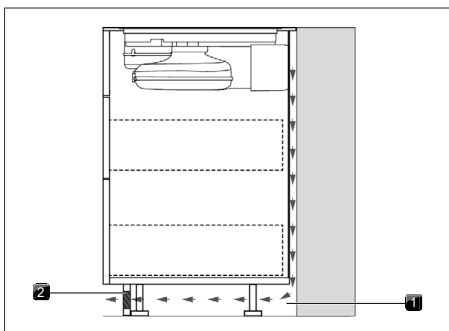

Fig. 11.10 Return flow aperture in the plinth area

- [1] Return flow aperture in the plinth $\geq 500 \text{ cm}^2$ [2] Return flow of recirculated air

11.7.2 Installation variants (A and B) for recirculation appliances

There are 2 installation variants for recirculation appliances:

A: floor unit with continuous back panel

The recirculated air is guided through the connection with the back wall of the air purification box directly behind the back panel of the unit. The recirculated air goes back in to the room through the return flow aperture.

For installation purposes, this means that:

- No false floor is necessary below the cooktop.
- There must be a cut-out in the back panel.

B: floor unit with false floor under the cooktop

The recirculated air is blown into the free space between the worktop and the false floor (the air purification box does not connect with the back panel). The recirculated air goes behind the back panel of the unit and through the return flow aperture back into the room.

For installation purposes, this means that:

- a false floor is necessary below the cooktop.
- There does not need to be a cut-out in the back panel of the unit.

11.7.3 Preparing the kitchen unit for installation variant A

- The floor unit must have a continuous back panel so that the recirculated air is not directed into the front furniture body compartment.
- There must be a cut-out in the back panel.

- A minimum clearance of 25 mm between the back panel of the unit and an adjacent kitchen unit or room wall must be kept for the return flow aperture.
- No false floor is necessary below the cooktop.

Adjusting the back panel of the unit

- ▶ Adapt the back panel according to the required installation dimensions.
- ▶ If necessary, move the back panel.
- ▶ If necessary, extend the height of the back panel so that the unit is closed to the front.
- ▶ Position the template on the back panel of the unit with the help of the markings and instructions.
- ▶ Mark out the back panel cut-out.
- ▶ Cut out the back panel cut-out with a saw.

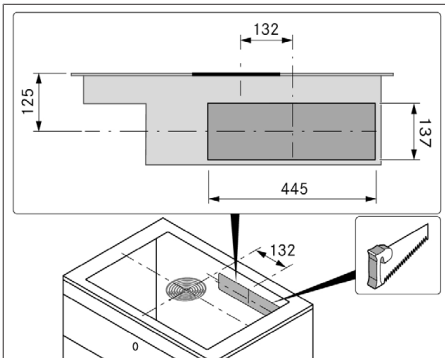

Fig. 11.11 Back panel cut-out

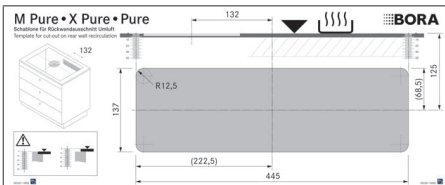

Fig. 11.12 Template for back panel cut-out

- i** Flush and surface mounting options must be taken into account when positioning the template. 125 mm from top edge of the cooktop to centre of cut-out.

11.7.4 Installation dimensions for installation variant A

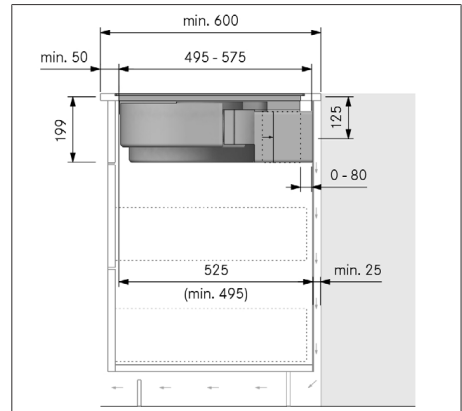

Fig. 11.13 Installation dimensions in the case of recirculated air, installation variant A

11.7.5 Extending the telescopic pull-out of the air purification box

The telescopic pull-out is used to connect the duct to the back panel of the kitchen unit. This can be used to flexibly bridge a gap of max. 80 mm between the cooktop and the back panel of the kitchen unit. If the depth of the worktop exceeds 675 mm in installation variant A, the telescopic pull-out must be extended using the accessory PULBTA (+ max. 105 mm).

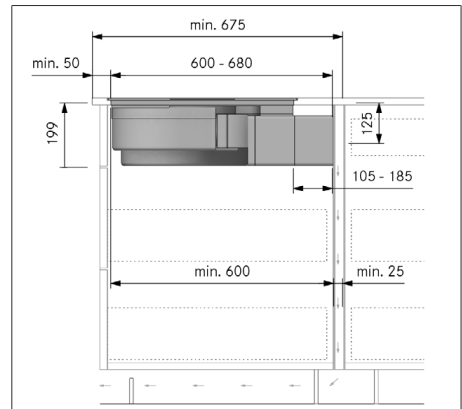

Fig. 11.14 Installation dimensions for recirculation installation variant A, depth of worktop 675 mm and over

- ▶ Remove the protective film from the adhesive tape on the telescopic pull-out.
- ▶ Fit the PULBTA extension on the telescopic pull-out.
- ▶ Remove the protective film from the adhesive tape on the PULBTA extension.

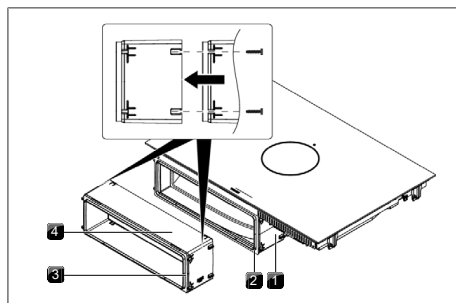

Fig. 11.15 Extending the telescopic pull-out

- | | |
|-------------------------|----------------------|
| [1] Telescopic pull-out | [2] Adhesive tape |
| [3] Adhesive tape | [4] PULBTA extension |

11.7.6 Preparing the kitchen unit for installation variant B

- A false floor must be provided for under the cooktop.
- The back panel of the unit must be flush with the false floor so that the recirculating air is not directed into the front of the unit.
- A minimum clearance of 25 mm between the back panel of the unit and an adjacent kitchen unit or room wall must be kept for the return flow aperture.

Adjusting the back panel of the unit

- ▶ Adapt the back panel according to the required installation dimensions.
- ▶ If necessary, move the back panel.
- ▶ Adjust the height of the back panel to the false floor so that they are flush with one another.

11.7.7 Installation dimensions for installation variant B

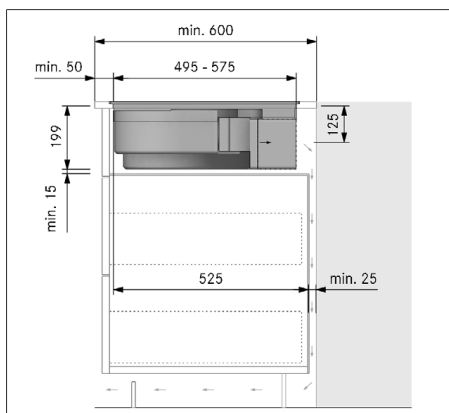

Fig. 11.16 Installation dimensions for recirculation installation variant B, depth of worktop 600 mm

11.8 Preparing the appliance

Attaching the sealing tape

- ▶ In the case of surface mounting, attach the enclosed sealing tape around the outer edges of the underside of the cooktop. Do not leave any gaps.
- ▶ In the case of flush installation, attach the sealing tape to the contact surfaces in the worktop cut-out, even if you are sealing the cooktop with a silicone sealing compound or similar.

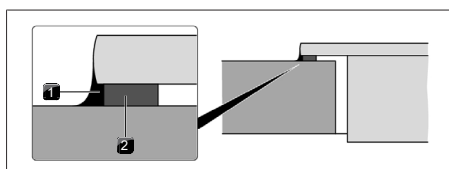

Fig. 11.17 Sealing tape in the case of surface mounting

- | | |
|----------------------|------------------|
| [1] Silicone sealant | [2] Sealing tape |
|----------------------|------------------|

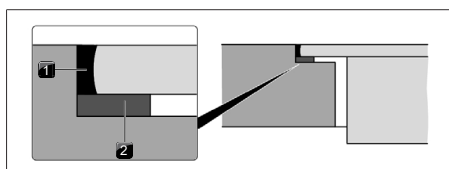

Fig. 11.18 Sealing tape in the case of flush installation

- | | |
|----------------------|------------------|
| [1] Silicone sealant | [2] Sealing tape |
|----------------------|------------------|

Fitting the installation clamps

- ▶ Push 2 installation clamps onto each side of the cooktop until they come to a stop in the retaining brackets provided.

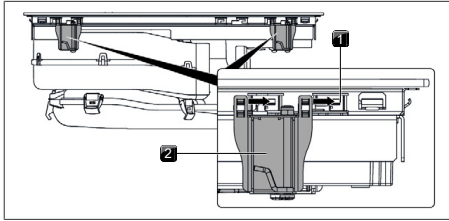

Fig. 11.19 Fitting the installation clamps

- [1] Retaining brackets [2] Installation clamps

11.9 Installing the cooktop

11.9.1 Inserting the cooktop

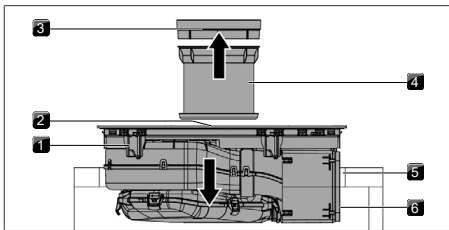

Fig. 11.20 Positioning the cooktop in the centre

- [1] Cooktop [2] Air inlet opening
[3] Air inlet nozzle [4] Stainless steel grease filter
[5] Worktop cut-out [6] Adhesive tape

- ▶ Before inserting the cooktop, remove the air inlet nozzle and the stainless steel grease filter.
- ▶ Remove the protective film from the adhesive tape on the front of the telescopic pull-out.
- ▶ Use the inlet opening as a handle during insertion.
- ▶ Keep the cooktop straight as you lift it into the worktop cut-out.
- ▶ Insert the cooktop into the centre of the worktop cut-out.
- ▶ Precisely align the cooktop.

i Make sure that the cooktop sealing tape is flat against the worktop in the case of surface mounting.

i Make sure that the cooktop sealing tape is well sealed all the way round in the case of flush installation.

Height adjustment plates for flush installation (optional)

To prevent slipping, the height adjustment plates are self-adhesive.

- ▶ If applicable, insert the height adjustment plates.
- ▶ Place the height adjustment plates next to the sealing tape.

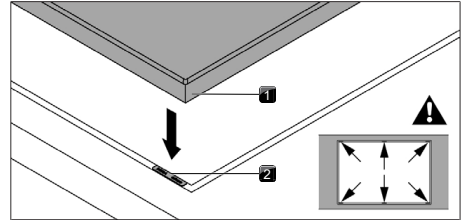

Fig. 11.21 Positioning the height adjustment plates

- [1] Cooktop [2] Height adjustment plate

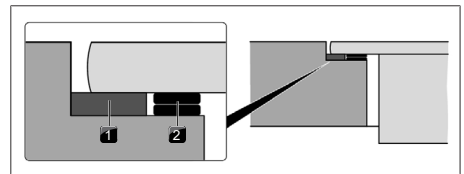

Fig. 11.22 Height adjustment plates

- [1] Sealing tape [2] Height adjustment plate

11.9.2 Securing the cooktop

- ▶ Secure the cooktop to the worktop with the fixing bracket on the installation clamp.
- ▶ Tightening torque: max. 2.2 Nm.

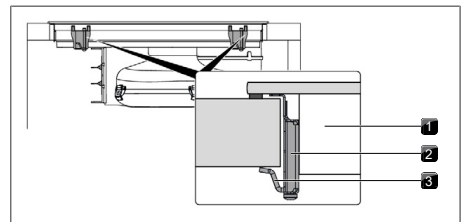

Fig. 11.23 Securing the cooktop in the middle

- [1] Cooktop [2] Mounting bracket
[3] Fixing bracket

11.9.3 Connecting the appliance to the duct system

- i** The duct system must be fitted to the appliance free of load and with the power supply switched off.
- i** When attaching the seals, ensure that an airtight seal is created with the connecting duct piece when the seals are compressed.
- ▶ Use only BORA Ecotube duct parts.
- ▶ Do not use flexible or fabric hoses.
- ▶ Pull the seal onto the exhaust opening on the appliance. The seal will need to be stretched slightly.
- ▶ Push the duct part to be connected with the coupling onto the exhaust opening with the seal.
- ▶ Ensure that the seal is not displaced.

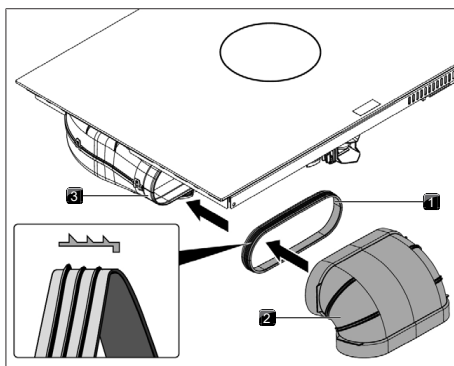

Fig. 11.24 Connecting the duct system

- [1] Seal
- [2] Duct part
- [3] Exhaust opening

11.9.4 Making a connection with the back panel in installation variant A

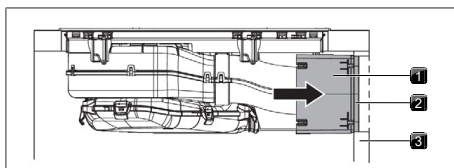

Fig. 11.25 Connection with the back panel

- [1] Telescopic pull-out
- [2] Adhesive tape
- [3] Back panel of unit

- ▶ Push the telescopic pull-out until it is tight up against the back panel of the unit.
- With the telescopic pull-out the distance to the back panel of the unit can be flexibly bridged.
- ▶ Check that the telescopic pull-out fits accurately, is flush with the cut-out on the back panel of the unit and closes it off.
- ▶ Secure the telescopic pull-out to the back panel of the unit using the adhesive tape.

11.9.5 How to fit the odour filter

- i** See chapter Cleaning and maintenance, 'How to replace the odour filter'

11.10 Connecting the power supply

- ▶ Observe all safety and warning information (see "2 Safety").
- i** Assembly, installation and commissioning must always occur in line with national laws, regulations and standards. The work must be performed by qualified specialists who know and comply with the additional regulations of the local energy supply companies.
- i** Connections via plug-in contacts (Schuko plugs) are not permitted.
- i** Single-phase connection: the appliance complies with the requirements of IEC 61000-3-12.

- ▶ Switch off the main switch/automatic circuit breaker before connecting the cooktop.
- ▶ Secure the main switch/automatic circuit breaker against being switched back on without permission.
- ▶ Make sure the power to the appliance is disconnected.
- ▶ Connect the cooktop exclusively via a fixed connection to an H 05 VV-F power supply cable with corresponding minimum cross-section.

Connection	Fuse protection	Minimum cross-section
3-phase connection	3 x 16 A	2.5 mm ²
2-phase connection	2 x 16 A	2.5 mm ²
Single-phase connection	1 x 32 A	4 mm ²

Tab. 11.2 Fuse protection and minimum cross-section

- ▶ Connect the power supply cable to the power supply of the appliance in accordance with the relevant connection diagram.

- ▶ For a single-phase or two-phase connection, connect the relevant contacts using the bridge provided.
- ▶ Secure the power supply cable with the strain relief clamp.
- ▶ Close the power supply housing with the power supply cover.
- ▶ Lay the connection cable along the mounting eyes with the help of the cable ties.
- ▶ Ensure that the cable is not trapped or damaged and is not able to come into contact with any hot areas on the cooktop.
- ▶ Check that installation has been carried out correctly.

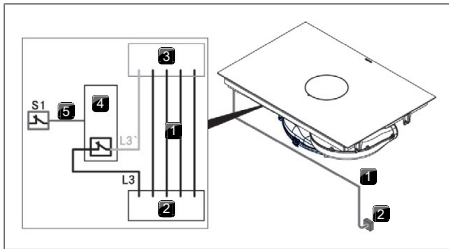

Fig. 11.26 Connection diagram with external switch contact

- [1] Power supply cable
- [2] Power supply
- [3] Appliance power supply
- [4] Switch relay
- [5] Switch connection S1 and [S1] External switch contact switch relay

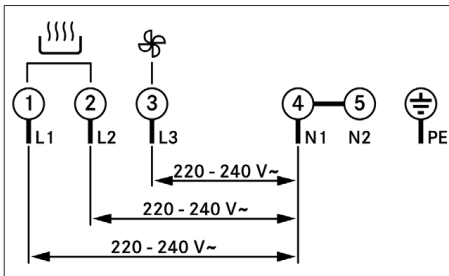

Fig. 11.27 Connection diagram for 3-phase connection

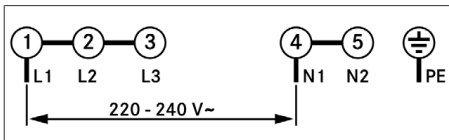

Fig. 11.28 Connection diagram for 1-phase connection

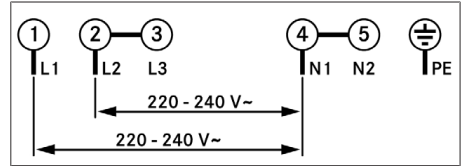

Fig. 11.29 Connection diagram for 2-phase connection

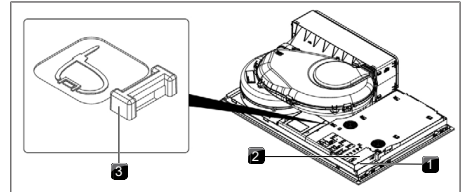

Fig. 11.30 Electrical connections of the cooktop

- [1] Power supply
- [2] Power supply cover
- [3] Mounting eyes

11.11 Initial operation

i During initial operation some basic settings (basic configuration) must be applied using the dealer and service menu.

11.11.1 Dealer and service menu

- i** The dealer and service menu can be called up up to 2 minutes after the appliance has been connected to the power supply.
- i** The system adopts and saves the settings made when you exit the corresponding menu item.
- i** Below you will find explanations on how to use the menu and a description of the most important menu items.





Dealer and service menu overview

Menu item/Description/Selection area	Factory setting
B Extraction system (exhaust air/ recirculation system)	Recirculation
C Power management	3
D Demo mode	Off

Tab. 11.3 Menu overview

Calling up the dealer and service menu

- ▶ Connect the appliance to the power supply.
- The standard display appears and the fan symbol pulses for 2 minutes.

- ▶ Long press on the fan button .
- 4 input points  are shown.
- ▶ Keep the fan button  pressed and at the same time press the input points  in the specified order.
- Menu item B is displayed.

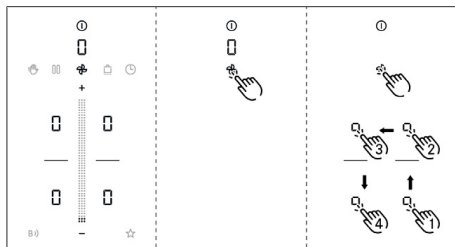





Fig. 11.31 Calling up the dealer and service menu

11.11.2 Menu item B: Extraction system configuration

There are two operating modes to choose from:

- Operating mode : recirculation system (factory setting)
- Operating mode : exhaust air system
- ▶ Select the appropriate operating mode.
- ▶ Confirm and save the setting by moving to the next menu item (tap the multi-function display/indicator ).

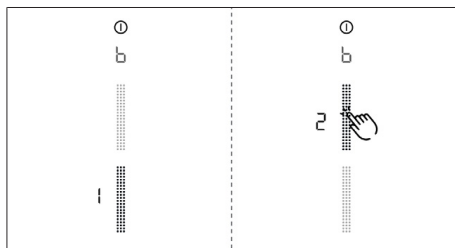

Fig. 11.32 Display Menu item B: Configuring the extraction system

11.11.3 Menu item C: Power management

The total appliance power can be reduced if the required electrical power cannot be provided at the installation site.

There are three power management settings to choose from:

Power management settings	Connection	Maximum power consumption	Fuse protection
C3	3-phase	7360 W	3 x 16 A
C3	2-phase	7360 W	2 x 16 A
C3	1-phase	7360 W	1 x 32 A
C2	1-phase	4400 W	1 x 20 A
C1	1-phase	3600 W	1 x 16 A

Tab. 11.4 Power management

- ▶ Select the appropriate setting.
- ▶ Confirm and save the setting by moving to the next menu item (tap the multi-function display/indicator .

 The cooking zone power restrictions automatically implemented by the appliance are determined according to the total power set.

 Despite power restrictions, the minimum cross-section of the power supply cable must not be reduced (see table “Fuse protection and minimum cross-section”).

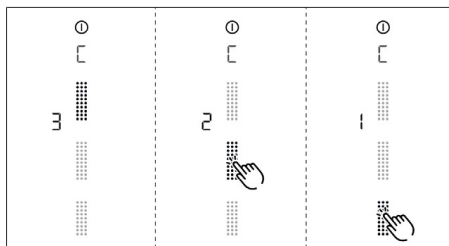





Fig. 11.33 Display menu item C: power management

11.11.4 Menu item D: Demo mode

The appliance can be set to demo mode, which includes all operating functions, but the heating function of the cooktops is deactivated.

- ▶ Tap the top slider segment.
- The demo mode symbol  is displayed on all cooking zones for one second.
-  is displayed.
- ▶ Confirm and save the setting by moving to the next menu item (tap the multi-function display/indicator .

 Pan size recognition is deactivated in demo mode.

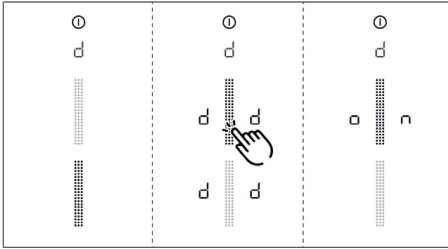

Fig. 11.34 Display Menu item D: Demo mode

Closing the dealer and service menu

When you have been through all of the basic configuration menu items:

- ▶ Long press on the multi-function display.

11.11.5 Function test

- ▶ Carry out a thorough function test on all appliances.
- ▶ In the event of error messages, see the "Troubleshooting" chapter.

11.12 Sealing the appliance

- ▶ Once all of the installation work is complete, seal the appliance with black, heat-resistant silicone sealant.
- ▶ Make sure that no silicone sealant gets under the cooktop.

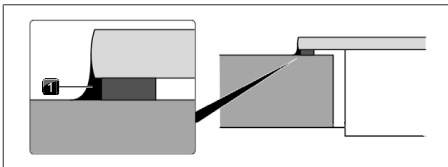

Fig. 11.35 Silicone sealant for surface mounting

[1] Silicone sealant

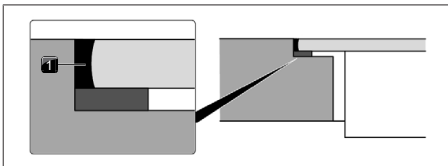

Fig. 11.36 Silicone sealant for flush installation

[1] Silicone sealant

11.13 Handover to user

Once installation is complete:

- ▶ Explain the main functions to the user.
- ▶ Explain all safety-related aspects of operation and handling to the user.
- ▶ Provide the user with the accessories and operating and installation instructions, which are to be kept in a safe place.

12 Decommissioning, disassembly and disposal

- ▶ Observe all safety and warning information (see "2 Safety").
- ▶ Please observe the documents and instructions provided.

12.1 Decommissioning

Decommissioning refers to ultimate decommissioning and disassembly. Following decommissioning, the appliance can either be installed in another unit, sold on privately or disposed of.

- ▶ **i** The electricity connection may only be disconnected and cut off by certified specialists.

- ▶ Switch the appliance off before decommissioning (see operating instructions)
- ▶ Disconnect the appliance from the power supply.

12.2 Disassembly

To be removed, the appliance must be accessible for disassembly and disconnected from the power supply.

- ▶ Remove the silicone seals.
- ▶ Disconnect the appliance from the exhaust duct.
- ▶ Lift the appliance up and out through the top of the worktop.
- ▶ Remove any other accessories.
- ▶ Dispose of the old appliance and any soiled accessories as described under "Environmentally-friendly disposal".

12.3 Environmentally-friendly disposal

12.3.1 Disposal of transport packaging

- i** The packaging protects the appliance from damage during transport. The packaging materials have been selected taking into account the environment and their disposal and are therefore recyclable.

Recycling the packaging saves raw materials and reduces waste. Your specialist retailer will take the packaging back.

- ▶ Give the packaging to your specialist retailer or
- ▶ Dispose of the packaging correctly observing regional regulations.

12.3.2 Disposal of accessories

Dispose of unnecessary or used accessories (activated charcoal filters, etc.) accordingly taking into account the regional regulations.

12.3.3 Disposal of the old appliance



Electrical appliances with this mark must not be disposed of in the household waste at the end of their service life. They must be disposed of at a collection point for the recycling of electrical or electronic appliances. Information on this can be obtained from the city or local councils.

Waste electrical and electronic appliances often still contain valuable materials. However, they also contain harmful substances that were necessary to make them work and ensure their safety. If placed in the household waste or handled incorrectly, they may harm human health and damage the environment.

- ▶ Never dispose of your old appliance in the household waste.
- ▶ Take the appliance to a regional collection point for the return and further processing of electrical and electronic components and other materials.

13 Warranty, technical service, spare parts, accessories

- ▶ Observe all safety and warning information (see "2 Safety").

13.1 BORA manufacturer's warranty

BORA provides its end customers with a 2-year manufacturer's warranty for its products. The end customer is entitled to this warranty in addition to the statutory claims for defects against the sellers of our products.

The manufacturer's warranty applies to the BORA products listed here, which are sold by authorised BORA retailers or by BORA trained salespersons and are installed within the European Union (overseas territories excluded), Switzerland, Liechtenstein, Ukraine, Russia, Norway, Serbia, Israel, UK, Iceland, India, Australia and New Zealand, with the exception of BORA products labelled as universal or accessories:

- Cooktops
- Cooktop extractor systems
- Fans

The manufacturer's warranty starts as soon as the BORA product is handed over to the end customer and is valid for 2 years. Registration on bora.com/registration enables the manufacturer's warranty to be extended to 3 years.

The manufacturer's warranty requires expert installation (in accordance with the valid BORA planning guide and operating instructions at the time of installation) of the BORA products by an authorised BORA dealer. During use, the end customer is to adhere to the specifications and instructions in the operating instructions.

When filing a warranty claim, BORA must be directly notified of the fault and the receipt must be presented. Alternatively, proof of purchase can be provided by registering on bora.com/registration.

BORA guarantees that all BORA products are free from material and production defects. The defect must exist prior to delivery of the product to the end customer. Filing a warranty claim does not interrupt the warranty period, nor shall the period start anew.

BORA will correct defects in BORA products at its own discretion by repairing or replacing the product. All costs for the correction of defects under the manufacturer's warranty shall be assumed by BORA. Expressly not covered by the BORA manufacturer's warranty are:

- BORA products that were not sold by authorised BORA dealers or salespersons trained by BORA
- Damage caused by non-adherence to the operating instructions (including product care and cleaning). This represents improper use.
- Damage caused by normal use, e.g. traces of usage on the cooktop
- Damage caused by external influences (such as transport damage, ingress of condensation, damage caused by the elements such as a lightning strike)
- Damage caused by repairs or repair attempts that were not carried out by BORA or by persons authorised by BORA .
- Damage to the glass ceramic
- Injury caused by electrical voltage fluctuations
- Secondary damage or claims for damages beyond the defect
- Damage to plastic parts

Legal claims, particularly statutory claims for defects or product liability are not limited by the warranty and can be asserted free of charge.

If a defect is not covered by the manufacturer's warranty, a claim may be made against the BORA Technical Service.

BORA shall not assume the resulting costs.

The laws of the Federal Republic of Germany apply to these warranty conditions.

You can contact us at:

BORA Vertriebs GmbH & Co KG, Innstraße 1, 6342 Niederndorf, Austria

- Telephone: 00800 7890 0987
Monday to Thursday from 08:00-18:00 and Friday from 08:00-17:00
- Email: support@bora.com

13.1.1 Warranty extension

You can extend the warranty by registering at www.bora.com/registration .

13.2 Service

BORA Service:

see the back of these instructions

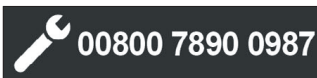

- ▶ In the case of faults you cannot fix yourself, contact your BORA specialist retailer or the BORA Service Team Team.

The BORA Service Team Team will require the type designation and serial number of your appliance (FD number).

This information is provided on the nameplate on the warranty form as well as on the bottom of the appliance.

13.3 Spare parts

- ▶ Only use original spare parts for repairs.
- ▶ Repairs may only be carried out by the BORA Service Team.

- i** Spare parts can be obtained from your BORA dealer, the BORA online service website at www.bora.com/service or by calling the service number provided.

13.4 Accessories

Accessories	PURMA 2/ PURMA 2R	PURMU 2/ PUR- MU2R
GFES – eSwap odour filter		✓
GFESP – eSwap odour filter Plus		✓
PUEF – Pure stainless steel grease filter	✓	✓
PUED2 – Pure air inlet nozzle for the second compact appliance generation, black	✓	✓
PUXED2 – X Pure air inlet nozzle for X Pure and X Pure Rough	✓	✓
USL515 – BORA side frame for cooktop depth 515 mm	✓	✓
USL515AB – side frame for cooktop depth 515 mm, All Black	✓	✓
KFR760AB – cooktop frame for width 760 mm	✓	✓
KWGPFI – grill pan for surface induction	✓	✓
UGS – glass ceramic scraper	✓	✓
UFKS – window contact switch	✓	
PULB – Pure air purification box (on PURA2/PURA2R only when converting from exhaust air to recirculation)	✓	✓
PULBTA – Pure air purification box with telescopic extension (on PURA2/PURA2R only when converting from exhaust air to recirculation)	✓	✓

Tab. 13.1 M Pure accessories

14 Product data sheets

14.1 PURMA2/PURMA2R product data sheet - cooktop extractor

Product information according to Commission Delegated Regulation (EU) No. 65/2014 and Regulation (EU) No. 66/2014.

Manufacturer	BORA		
Model identification	PURMA2 PURMA2R		
	Symbol	Value	Unit
Energy consumption			
Annual energy consumption	AEC_{hood}	32.7	kWh/a
Energy efficiency class	-	A+	-
Energy efficiency index	EEl_{hood}	42.5	-
Flow volume			
Fluid dynamic efficiency	FDE_{hood}	33.3	-
Fluid dynamic efficiency class	-	A	-
Airflow at minimum speed in normal operation	-	181	m ³ /h
Airflow at maximum speed in normal operation	-	543	m ³ /h
Airflow when operated on the intensive level or fast mode level (power setting)	-	591	m ³ /h
Maximum airflow	Q_{max}	607.5	m ³ /h
Measured air flow rate at the best efficiency point	Q_{BEP}	305.5	m ³ /h
Measured air pressure at the best efficiency point	P_{BEP}	440	Pa
Measured electric power input at the best efficiency point	W_{BEP}	112.1	W
Time increase factor	f	0.8	-
Lighting			
Lighting efficiency	LE_{hood}	*	lx/W
Lighting efficiency class	-	*	-
Nominal power of the lighting system	W_L	*	W
Average illumination of the lighting system on the cooking surface	E_{middle}	*	lx
Grease filtering			
Grease filtering efficiency	GFE_{hood}	98.1	%
Grease filtering efficiency class	-	A	-
Airborne acoustical noise emission			
Sound power level at minimum available speed in normal operation	L_{WA}	41	dB re 1 pW
Sound power level at maximum available speed in normal operation	L_{WA}	67	dB re 1 pW
Sound power level when operated on the intensive level or fast mode level (power setting)	L_{WA}	69	dB re 1 pW
Sound pressure level at minimum available speed in normal operation**	L_{pA}	29	dB re 20 µPa
Sound pressure level at maximum available speed in normal operation**	L_{pA}	54	dB re 20 µPa
Sound pressure level when operating on the intensive level or fast mode level (power setting)**	L_{pA}	56	dB re 20 µPa
Power consumption			
Power consumption in off mode	P_o	*	W

Manufacturer	BORA		
Model identification	PURMA2 PURMA2R		
Power consumption in standby mode	P _s	0.19	W

Tab. 14.1 Cooktop extractor product data sheet

* Does not apply to this product.

** Voluntary declaration

14.2 M Pure - Cooktop product data sheet

Product information according to Regulation (EU) Nr. 66/2014.

Manufacturer	BORA		
Model identification	PURMA2 PURMA2R PURMU2 PURMU2R		
Type of hob	Glass ceramic cooktop		
Number of cooking zones/cooking areas	4		
Heating technology	Induction cooking zones and cooking surfaces		
	Symbol	Value	Unit
Size of usable surface			
Front left cooking zone	∅	21.0	cm
Rear left cooking zone	∅	17.5	cm
Front right cooking area	L × W	23.0 × 23.0	cm
Rear right cooking area	L × W	23.0 × 23.0	cm
Energy consumption			
Front left cooking zone	EC _{electric cooking}	187.5	Wh/kg
Rear left cooking zone	EC _{electric cooking}	178.6	Wh/kg
Front right cooking area	EC _{electric cooking}	189.1	Wh/kg
Rear right cooking area	EC _{electric cooking}	181.8	Wh/kg
Right bridged cooking areas	EC _{electric cooking}	190.7	Wh/kg
Energy consumption of the hob	EC _{electric hob}	185.6	Wh/kg

Tab. 14.2 Cooktop product data sheet

Notes

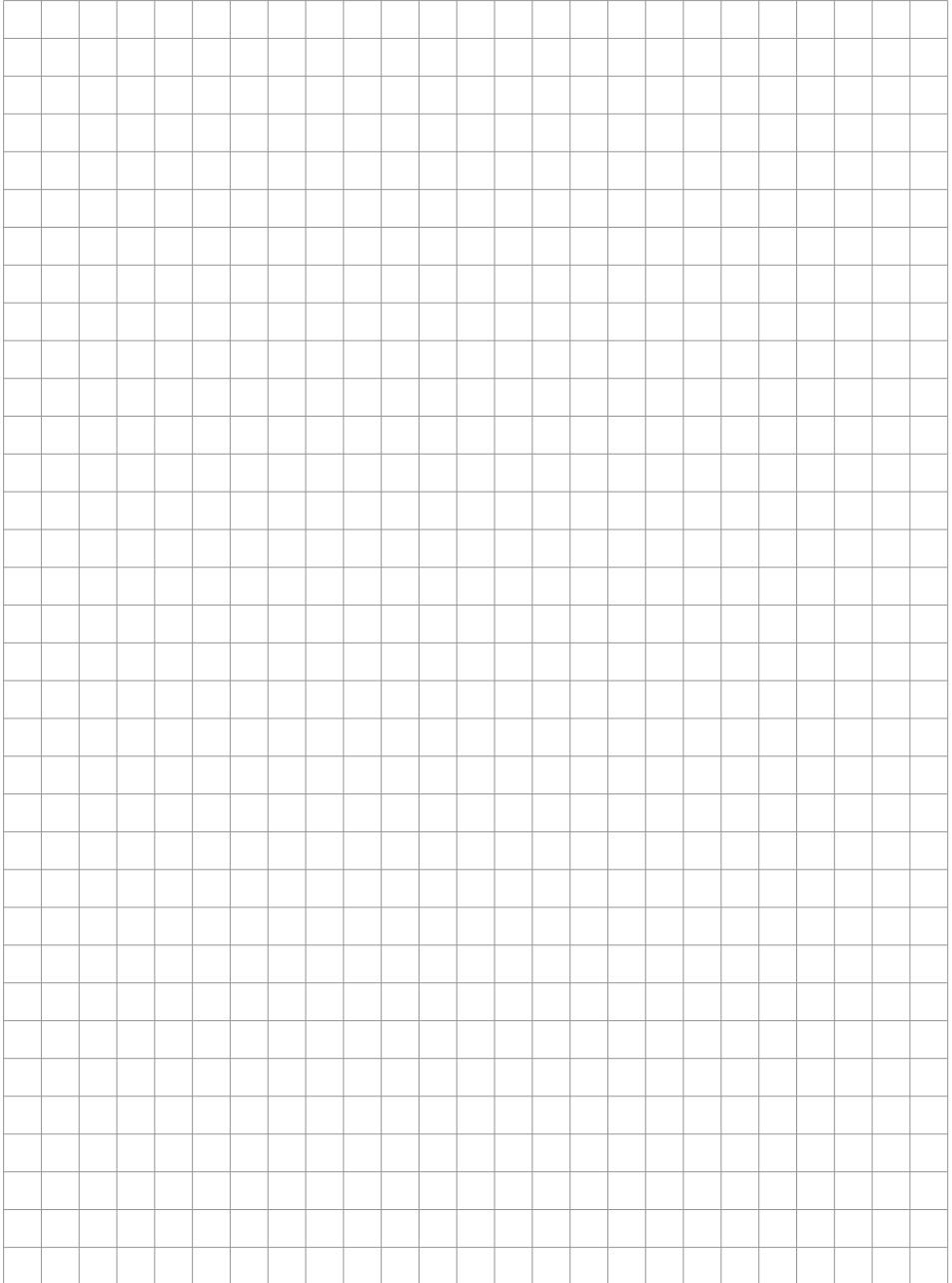

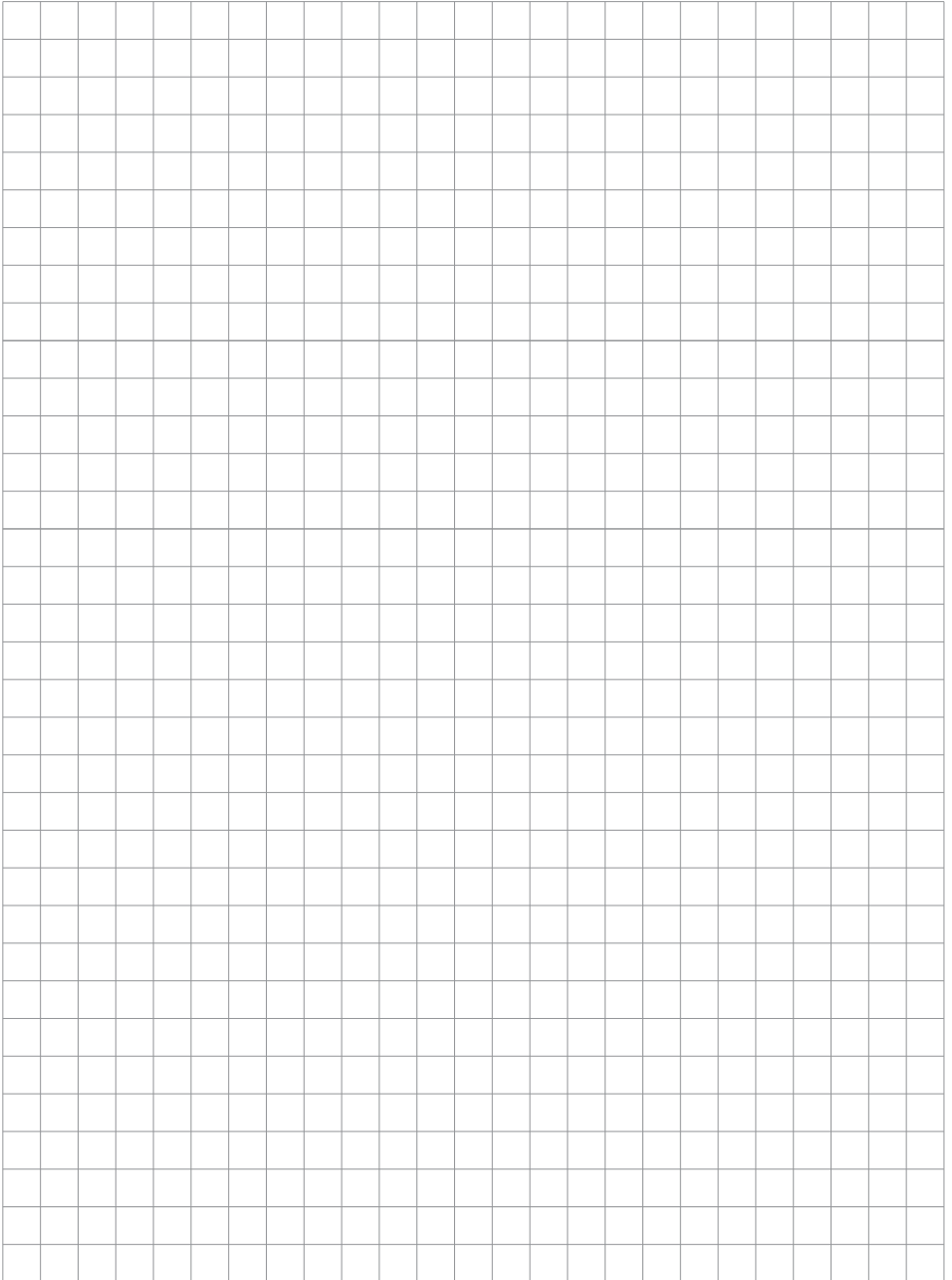

D

BORA Lüftungstechnik GmbH

Rosenheimer Str. 33
83064 Raubling
Deutschland
T +49 (0) 8035 / 9840-0
F +49 (0) 8035 / 9840-300
support@bora.com
bora.com

A

BORA Vertriebs GmbH & Co KG

Innstraße 1
6342 Niederndorf
Österreich
T +43 (0) 5373 / 62250-0
F +43 (0) 5373 / 62250-90
support@bora.com
bora.com

INT

BORA Holding GmbH

Innstraße 1
6342 Niederndorf
Austria
T +43 (0) 5373 / 62250-0
F +43 (0) 5373 / 62250-90
support@bora.com
bora.com

AU NZ

BORA APAC Pty Ltd

100 Victoria Road
Drummoyne NSW 2047
Australia
T +61 2 9719 2350
F +61 2 8076 3514
info@boraapac.com.au
bora-australia.com.au

